

UC 312-36 ASAHI

Insert bearings

TYPE: Ball bearings, Radial insert bearings, Grub screw to inner ring, Spherical outer ring, Series UC, seals on both side, inch size

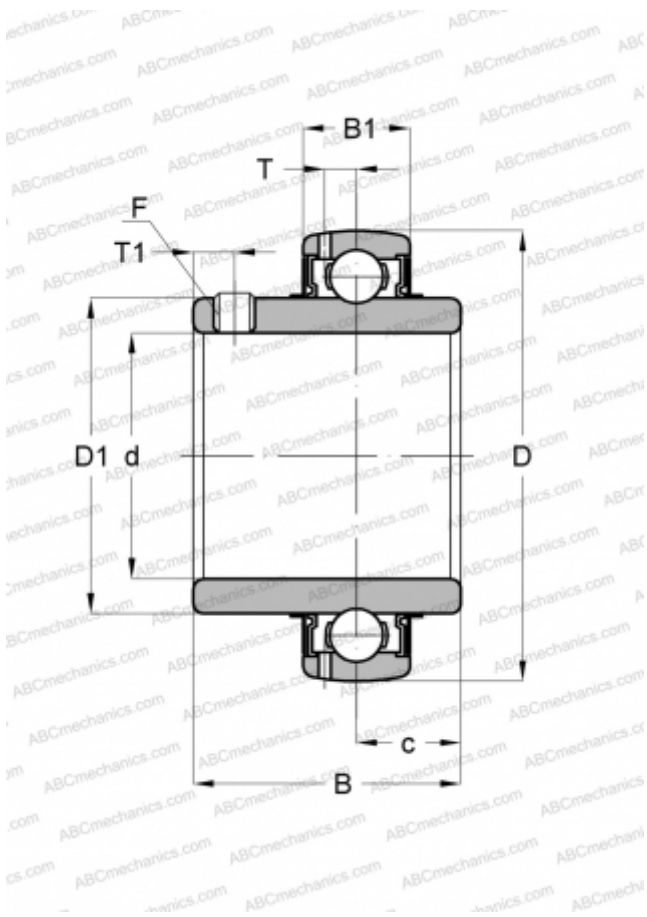

Technical specification

DIMENSIONS, MM

d	57,150
D	130,000
D1	82,499
B	70,993
B1	35,992
c	26,010
T	11,506
T1	11,989
F	1/2-20

WEIGHT, KG

2,590

MANUFACTURER

[ASAHI](#)