

UC 313-40 ASAHI

Insert bearings

TYPE: Ball bearings, Radial insert bearings, Grub screw to inner ring, Spherical outer ring, Series UC, seals on both side, inch size

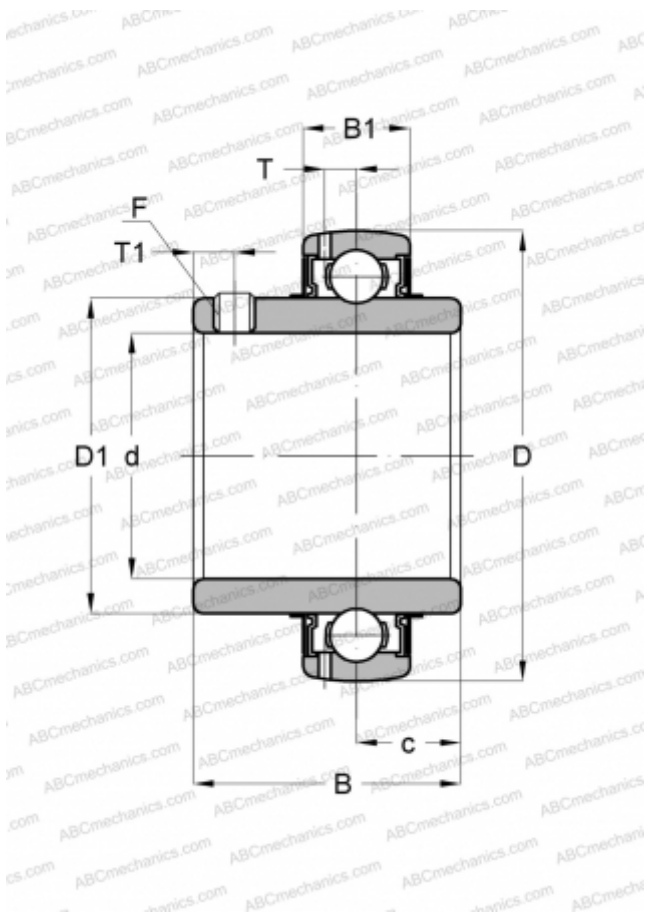

Technical specification

DIMENSIONS, MM

d	63,500
D	140,000
D1	88,494
B	75,006
B1	37,998
c	29,997
T	12,192
T1	11,989
F	1/2-20

WEIGHT, KG

3,148

MANUFACTURER

[ASAHI](#)