

UCW 202-9 ASAHI

Insert bearings

TYPE: Ball bearings, Radial insert bearings, Grub screw to inner ring, Spherical outer ring, Series UC, seals on both side, inch size

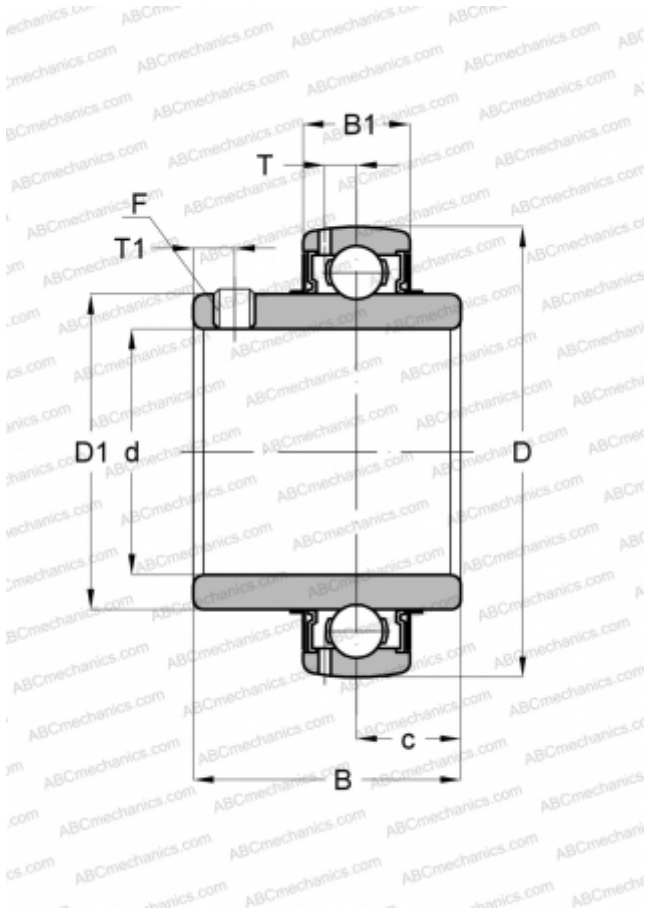

Technical specification

DIMENSIONS, MM

d	14,287
D	40,000
D1	24,689
B	26,010
B1	15,011
c	10,008
T	3,988
T1	3,988
F	10-32

WEIGHT, KG

0,109

MANUFACTURER

[ASAHI](#)