

UC X10-31 ASAHI

Insert bearings

TYPE: Ball bearings, Radial insert bearings, Grub screw to inner ring, Spherical outer ring, Series UC X, seals on both side, inch size

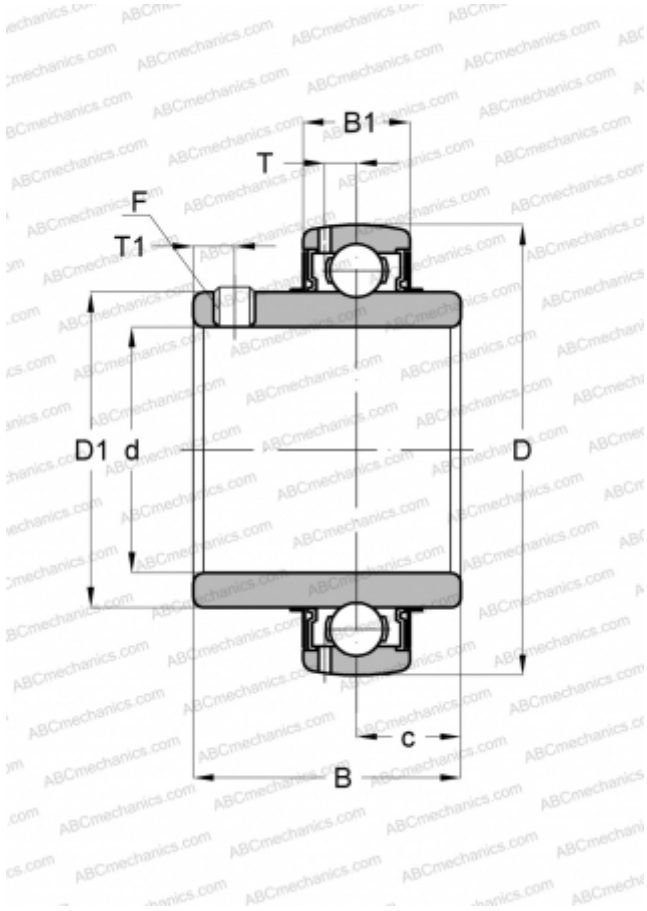

Technical specification

DIMENSIONS, MM

d	49,212
D	100,000
D1	69,748
B	55,601
B1	24,003
c	22,200
T	7,290
T1	8,992
F	3/8-24

WEIGHT, KG

1,211

MANUFACTURER

[ASAHI](#)