

UC X11-35 ASAHI

Insert bearings

TYPE: Ball bearings, Radial insert bearings, Grub screw to inner ring, Spherical outer ring, Series UC X, seals on both side, inch size

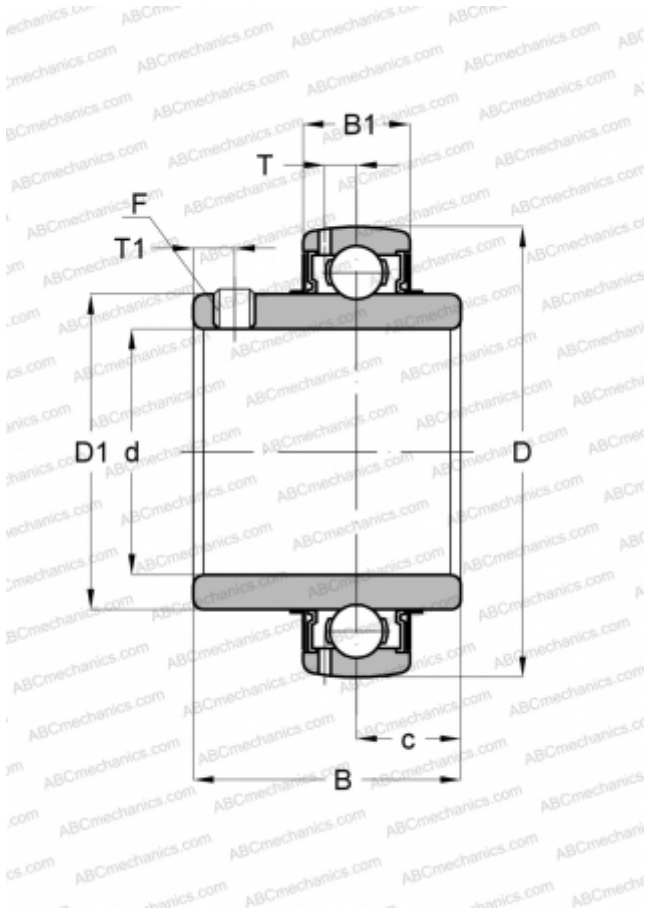

Technical specification

DIMENSIONS, MM

d	55,562
D	110,000
D1	76,987
B	65,100
B1	26,010
c	25,400
T	7,696
T1	10,008
F	3/8-24

WEIGHT, KG

1,719

MANUFACTURER

[ASAHI](#)