

UC X17-52 ASAHI

Insert bearings

TYPE: Ball bearings, Radial insert bearings, Grub screw to inner ring, Spherical outer ring, Series UC X, seals on both side, inch size

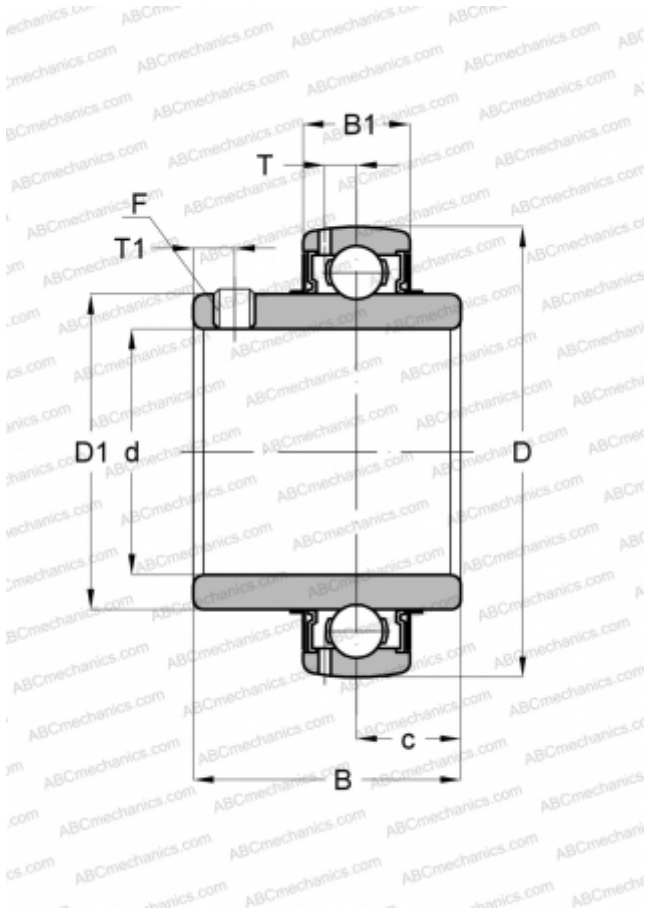

Technical specification

DIMENSIONS, MM

d	82,550
D	160,000
D1	111,506
B	96,012
B1	35,992
c	39,700
T	11,100
T1	11,989
F	1/2-20

WEIGHT, KG

4,831

MANUFACTURER

[ASAHI](#)