

## B 6 ASAHI

Insert bearings

TYPE: Ball bearings, Radial insert bearings, Grub screw to inner ring, Spherical outer ring, Series B, seals on both side

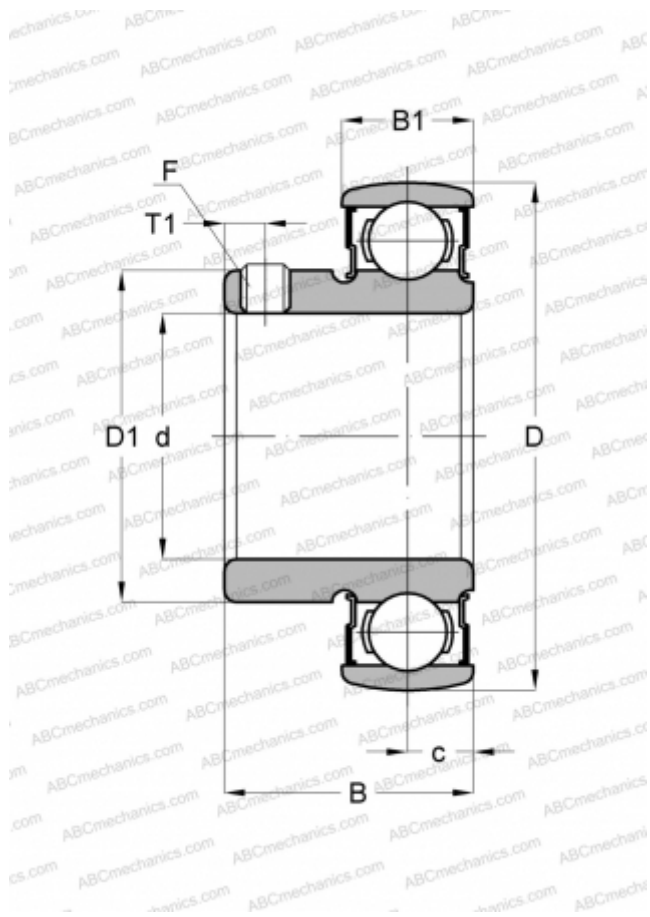

### Technical specification

#### DIMENSIONS, MM

d	30,000
D	62,000
D1	40,500
B	30,300
B1	16,000
c	8,000
T1	5,000
F	M6 x 0.75

#### WEIGHT, KG

0,250

#### MANUFACTURER

[ASAHI](#)