

B 2-9 ASAHI

Insert bearings

TYPE: Ball bearings, Radial insert bearings, Grub screw to inner ring, Spherical outer ring, Series B, seals on both side, inch size

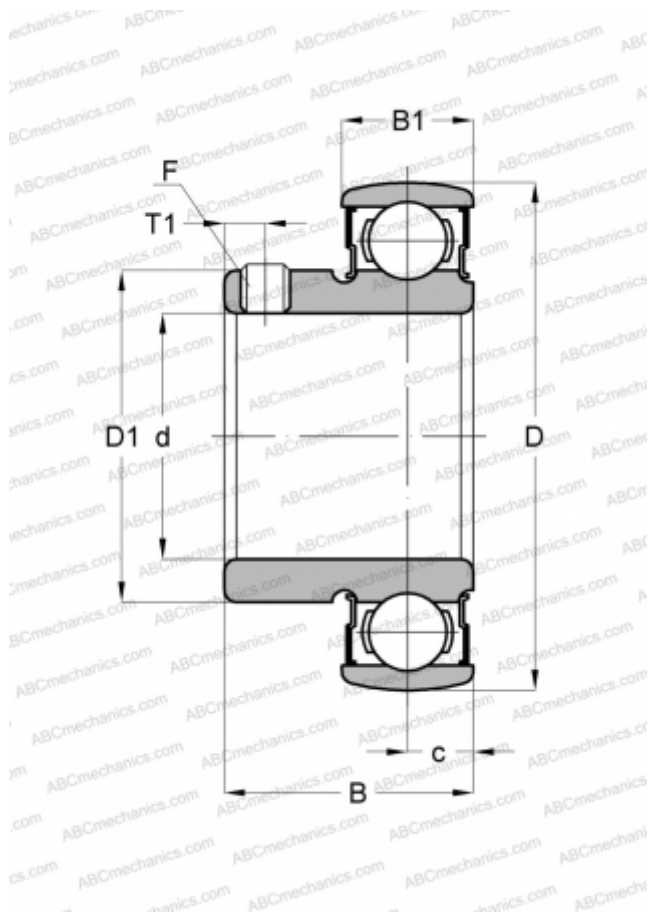

Technical specification

DIMENSIONS, MM

d	14,287
D	40,000
D1	24,689
B	21,996
B1	11,989
c	5,994
T1	3,988
F	10-32

WEIGHT, KG

0,091

MANUFACTURER

[ASAHI](#)