

B 4-12 ASAHI

Insert bearings

TYPE: Ball bearings, Radial insert bearings, Grub screw to inner ring, Spherical outer ring, Series B, seals on both side, inch size

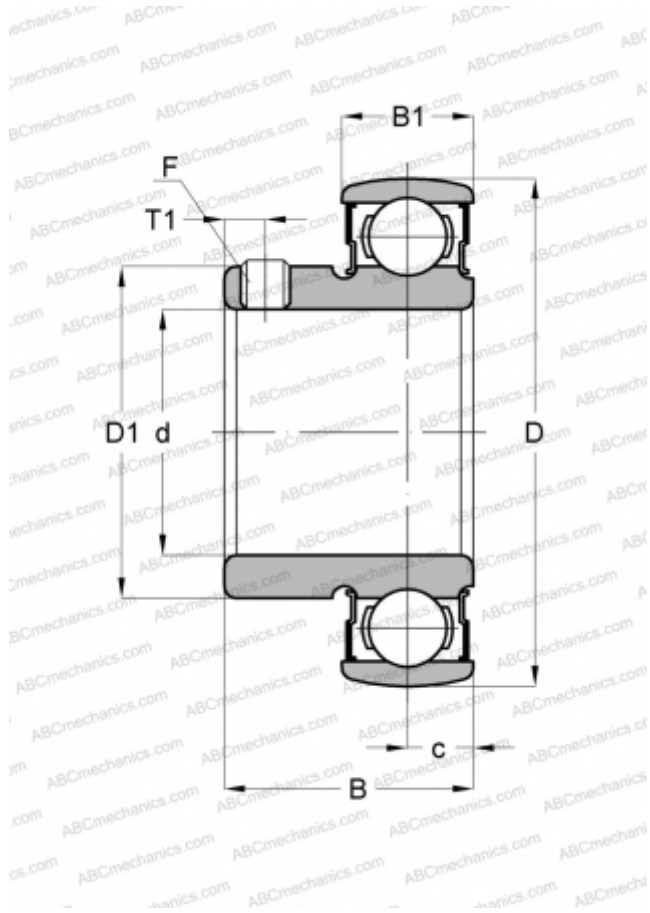

Technical specification

DIMENSIONS, MM

d	19,050
D	47,000
D1	29,007
B	24,689
B1	13,995
c	7,010
T1	4,496
F	10-32

WEIGHT, KG

0,118

MANUFACTURER

[ASAHI](#)