

B 5-16 ASAHI

Insert bearings

TYPE: Ball bearings, Radial insert bearings, Grub screw to inner ring, Spherical outer ring, Series B, seals on both side, inch size

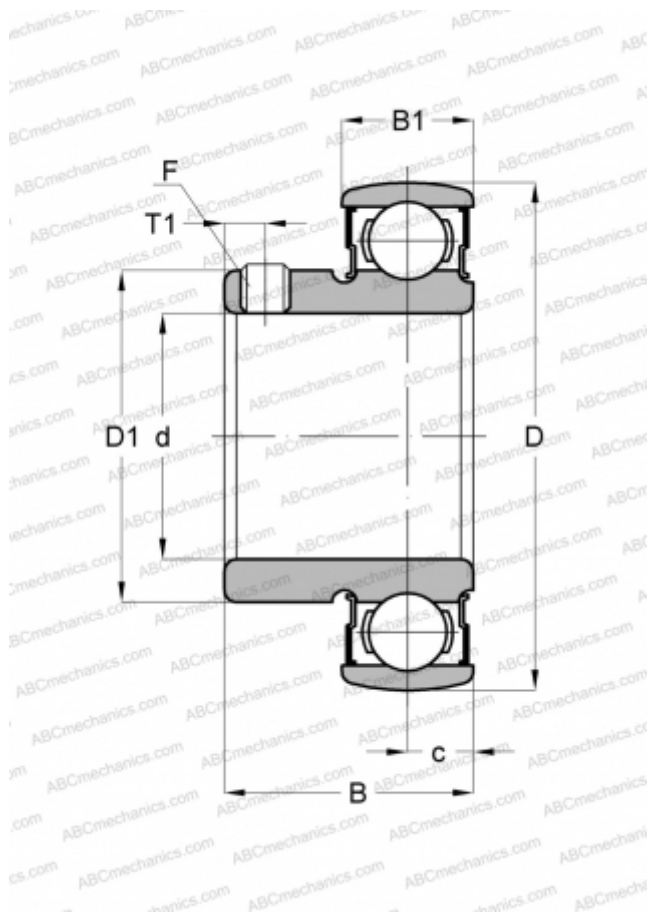

Technical specification

DIMENSIONS, MM

d	25,400
D	51,999
D1	34,011
B	27,000
B1	15,011
c	7,493
T1	5,004
F	1/4-28

WEIGHT, KG

0,159

MANUFACTURER

[ASAHI](#)