

## B 6-18 ASAHI

Insert bearings

TYPE: Ball bearings, Radial insert bearings, Grub screw to inner ring, Spherical outer ring, Series B, seals on both side, inch size

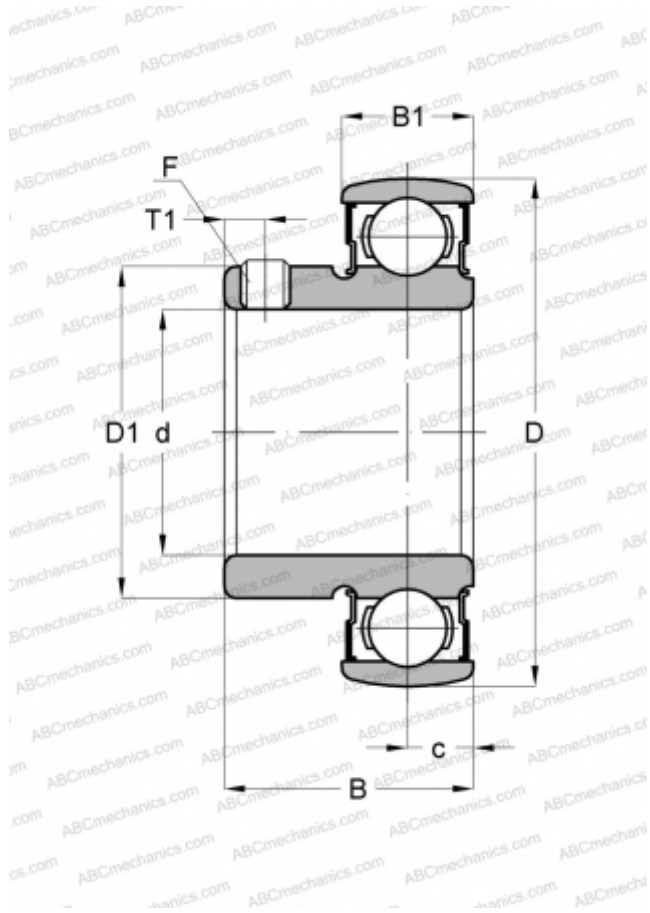

### Technical specification

#### DIMENSIONS, MM

d	28,575
D	61,999
D1	40,488
B	30,302
B1	16,002
c	8,001
T1	5,004
F	1/4-28

#### WEIGHT, KG

0,249

#### MANUFACTURER

[ASAHI](#)