

## B 7-23 ASAHI

Insert bearings

TYPE: Ball bearings, Radial insert bearings, Grub screw to inner ring, Spherical outer ring, Series B, seals on both side, inch size

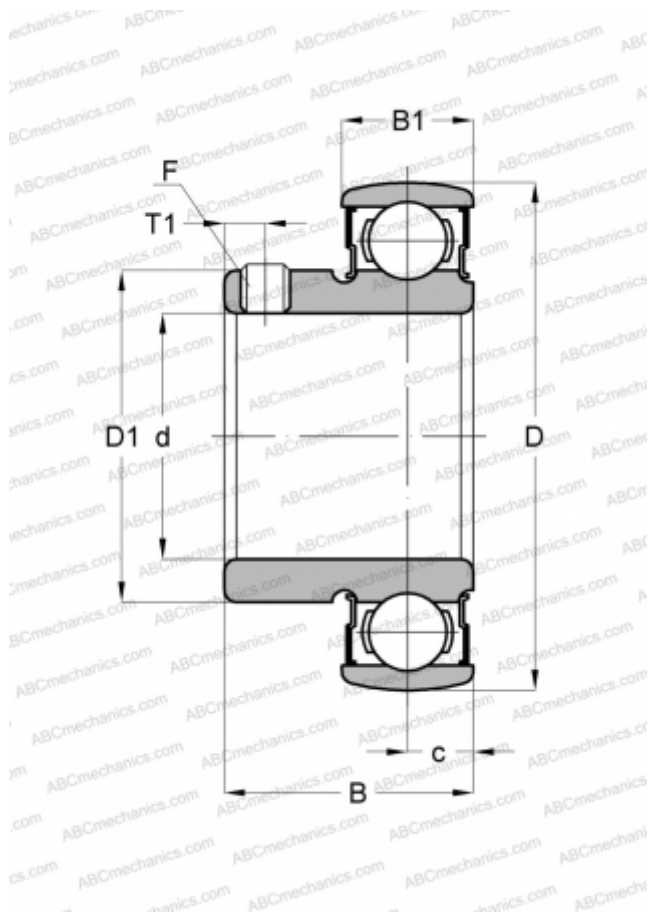

### Technical specification

#### DIMENSIONS, MM

d	36,512
D	71,999
D1	48,006
B	32,893
B1	16,993
c	8,509
T1	5,994
F	5/16-24

#### WEIGHT, KG

0,381

#### MANUFACTURER

[ASAHI](#)