

SER 206 ASAHI

Insert bearings

TYPE: Ball bearings, Radial insert bearings, Grub screw to inner ring, Cylindrical outer ring, snap ring, Series SER, seals on both side

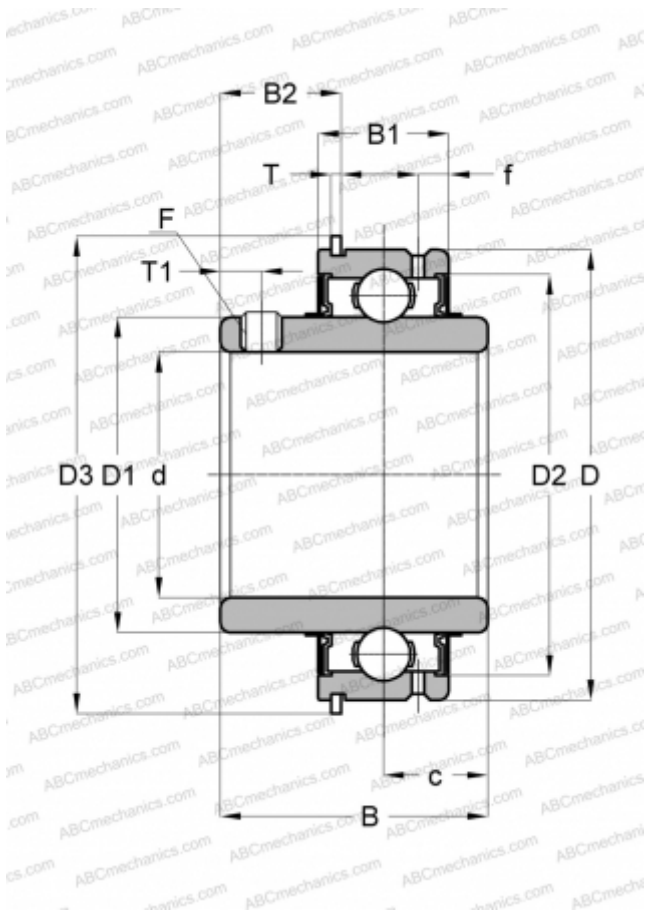

Technical specification

DIMENSIONS, MM

d	30,000
D	62,000
D1	40,500
D2	54,300
D3	67,700
B	38,100
B1	22,200
B2	15,930
f	5,600
c	15,900
T	1,650
T1	5,000
F	M6 x 0.75

WEIGHT, KG 0,380

MANUFACTURER [ASAHI](http://www.asahi.com)