

SER 207 ASAHI

Insert bearings

TYPE: Ball bearings, Radial insert bearings, Grub screw to inner ring, Cylindrical outer ring, snap ring, Series SER, seals on both side

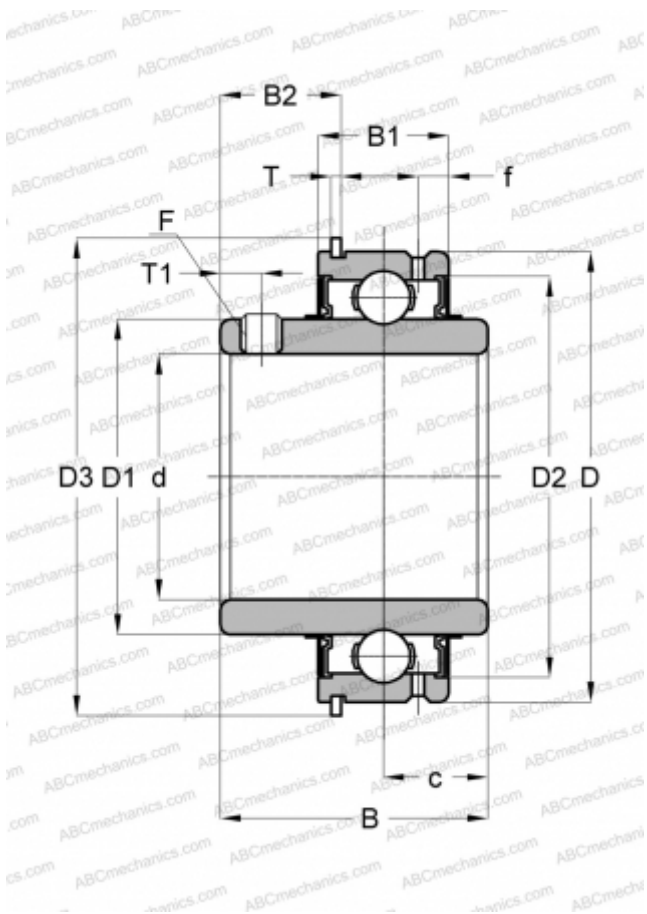

Technical specification

DIMENSIONS, MM

d	35,000
D	72,000
D1	48,000
D2	63,500
D3	78,600
B	42,900
B1	23,800
B2	18,320
f	5,600
c	17,500
T	1,650
T1	6,000
F	M8 x 1.0

WEIGHT, KG 0,560

MANUFACTURER [ASAHI](http://www.asahi.com)