

SER 209 ASAHI

Insert bearings

TYPE: Ball bearings, Radial insert bearings, Grub screw to inner ring, Cylindrical outer ring, snap ring, Series SER, seals on both side

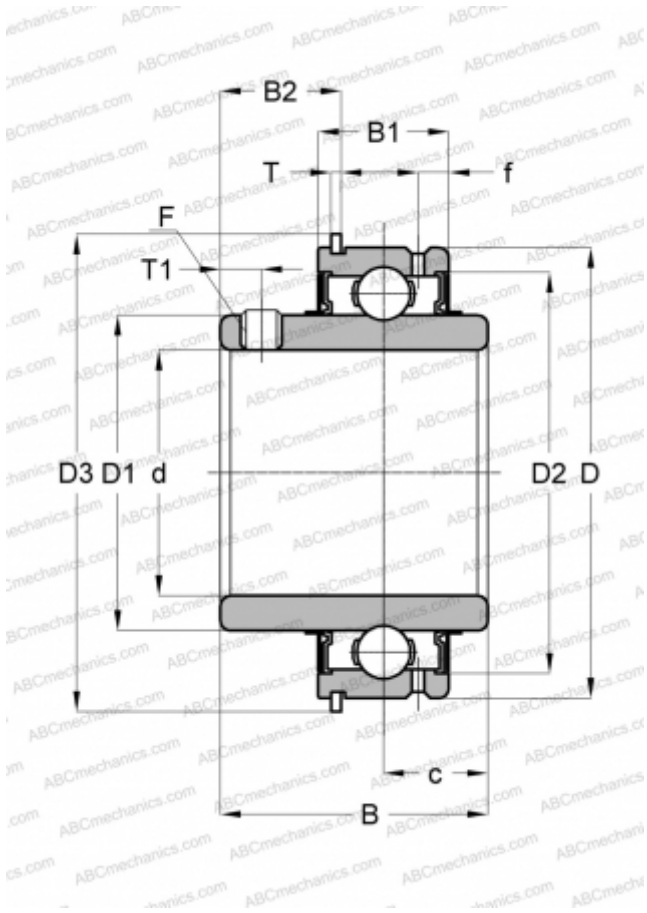

Technical specification

DIMENSIONS, MM

d	45,000
D	85,000
D1	57,300
D2	74,300
D3	91,600
B	49,200
B1	27,800
B2	21,100
f	6,400
c	19,000
T	1,650
T1	8,000
F	M8 x 1.0

WEIGHT, KG 0,950

MANUFACTURER [ASAHI](#)