

SER 210 ASAHI

Insert bearings

TYPE: Ball bearings, Radial insert bearings, Grub screw to inner ring, Cylindrical outer ring, snap ring, Series SER, seals on both side

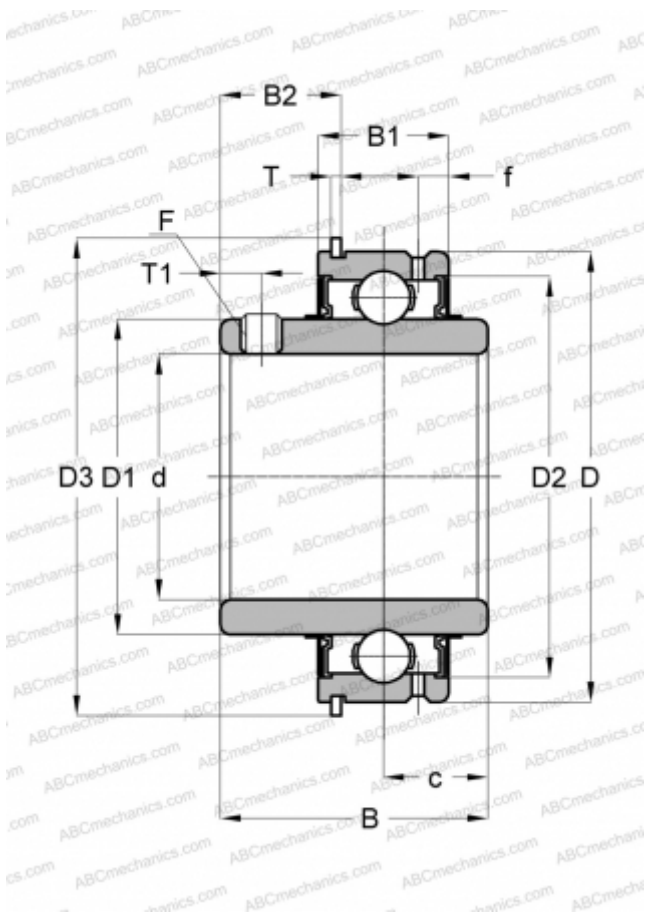

Technical specification

DIMENSIONS, MM

d	50,000
D	90,000
D1	63,000
D2	79,700
D3	96,500
B	51,600
B1	28,600
B2	23,840
f	7,500
c	19,000
T	2,410
T1	9,000
F	M10x 1.25

WEIGHT, KG 1,030

MANUFACTURER [ASAHI](http://www.asahi.com)