

SER 205-15 ASAHI

Insert bearings

TYPE: Ball bearings, Radial insert bearings, Grub screw to inner ring, Cylindrical outer ring, snap ring, Series SER, seals on both side, inch size

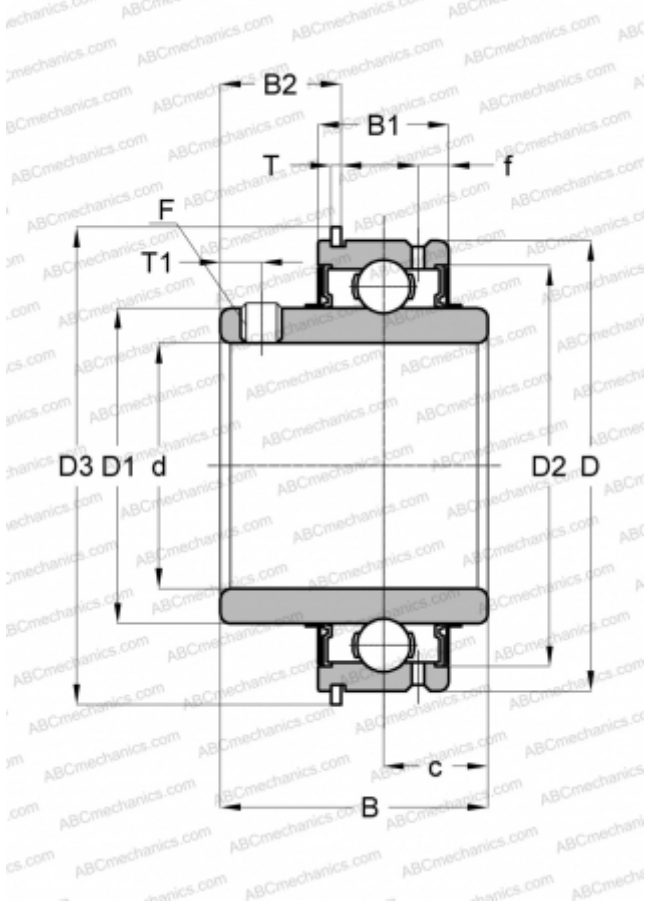

Technical specification

DIMENSIONS, MM

d	23,812
D	51,999
D1	34,011
D2	45,999
D3	57,912
B	34,925
B1	19,050
B2	15,748
f	5,159
c	13,096
T	1,067
T1	5,512
F	1/4-28

WEIGHT, KG 0,281

MANUFACTURER [ASAHI](http://www.asahi.com)