

SER 207-21 ASAHI

Insert bearings

TYPE: Ball bearings, Radial insert bearings, Grub screw to inner ring, Cylindrical outer ring, snap ring, Series SER, seals on both side, inch size

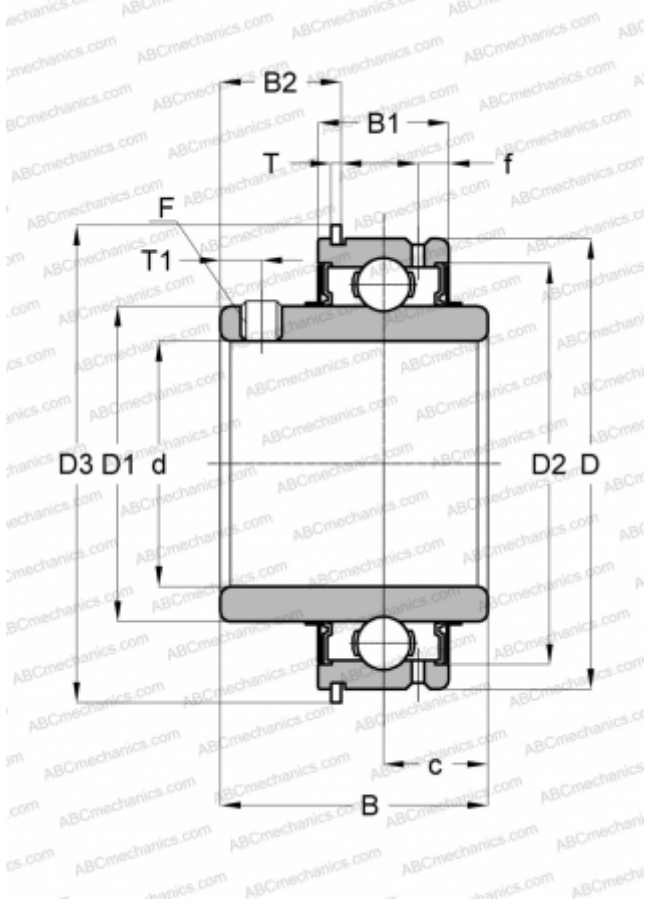

Technical specification

DIMENSIONS, MM

d	33,375
D	71,999
D1	48,006
D2	63,500
D3	78,613
B	42,863
B1	23,813
B2	18,313
f	6,096
c	17,463
T	1,651
T1	6,502
F	5/16-24

WEIGHT, KG

0,558

MANUFACTURER

[ASAHI](#)