

SER 208-24 ASAHI

Insert bearings

TYPE: Ball bearings, Radial insert bearings, Grub screw to inner ring, Cylindrical outer ring, snap ring, Series SER, seals on both side, inch size

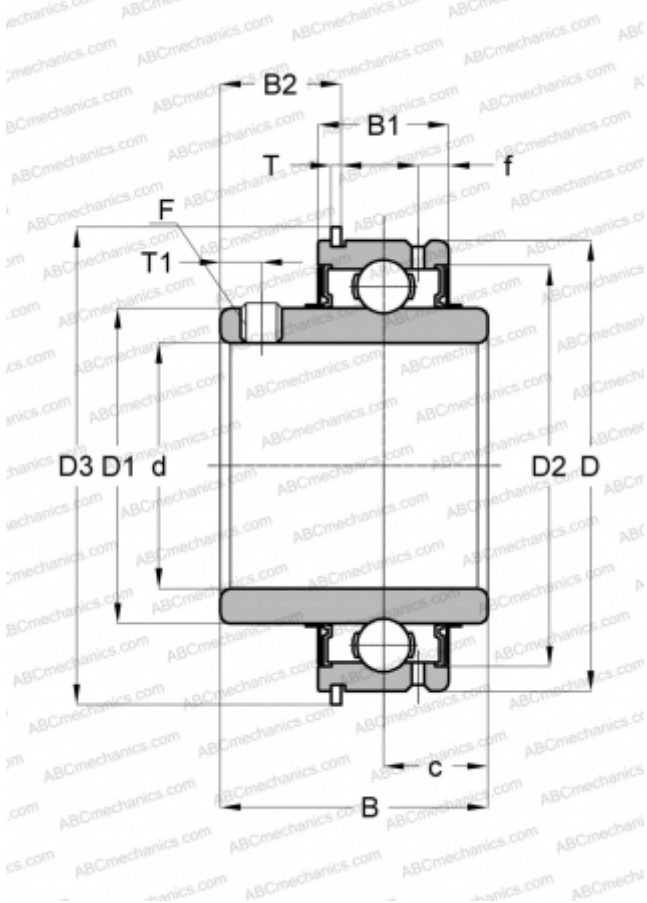

Technical specification

DIMENSIONS, MM

d	38,100
D	80,000
D1	53,010
D2	69,291
D3	86,614
B	49,213
B1	27,783
B2	21,107
f	7,341
c	19,050
T	1,651
T1	7,595
F	5/16-24

WEIGHT, KG 0,871

MANUFACTURER [ASAHI](http://www.asahi.com)