

SER 209-27 ASAHI

Insert bearings

TYPE: Ball bearings, Radial insert bearings, Grub screw to inner ring, Cylindrical outer ring, snap ring, Series SER, seals on both side, inch size

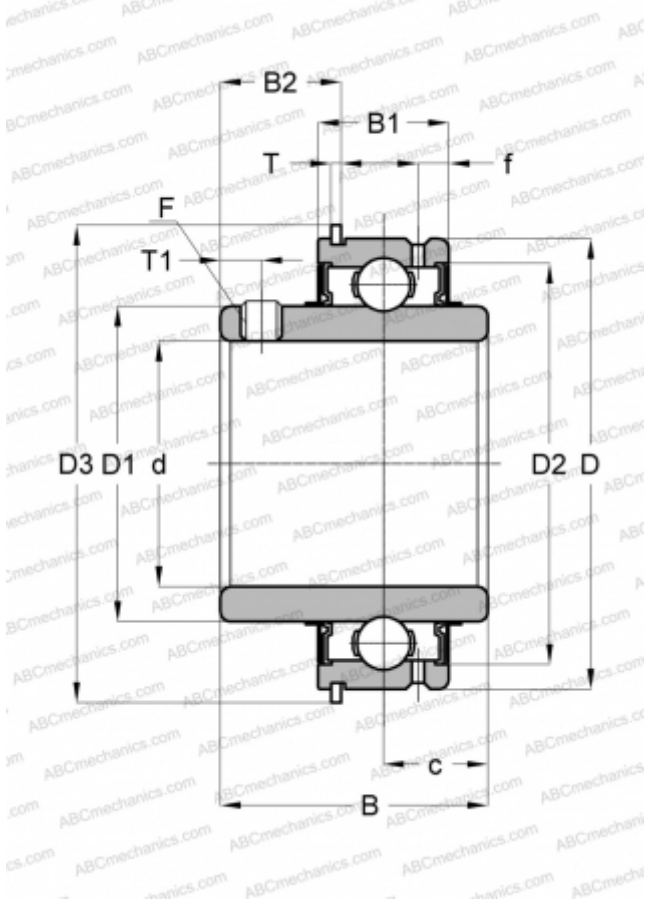

Technical specification

DIMENSIONS, MM

d	42,862
D	85,001
D1	57,302
D2	74,295
D3	91,592
B	49,213
B1	27,783
B2	21,107
f	6,350
c	19,050
T	1,651
T1	8,001
F	5/16-24

WEIGHT, KG 0,948

MANUFACTURER [ASAHI](#)