

## SER 209-28 ASAHI

Insert bearings

TYPE: Ball bearings, Radial insert bearings, Grub screw to inner ring, Cylindrical outer ring, snap ring, Series SER, seals on both side, inch size

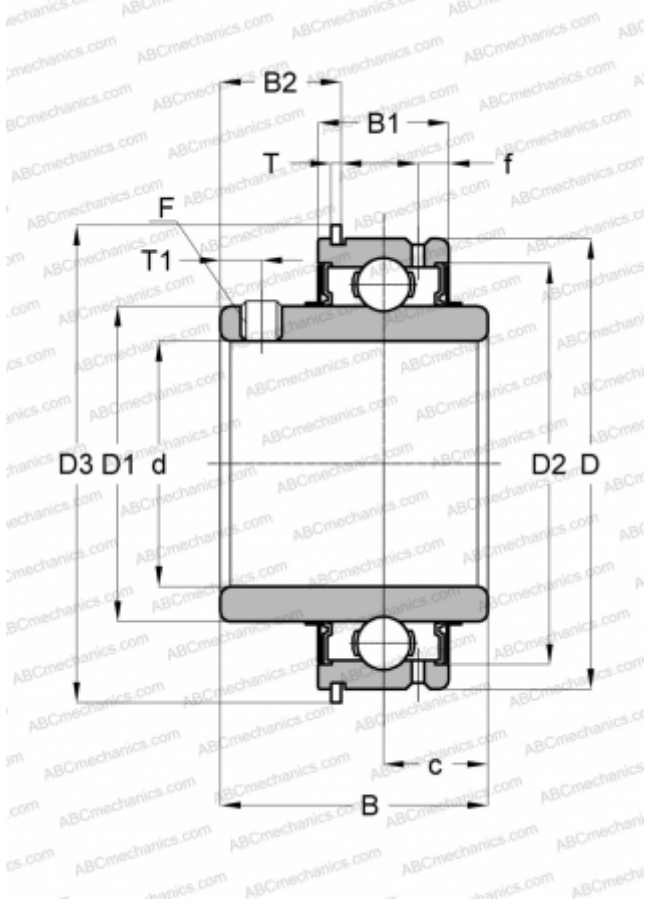

### Technical specification

#### DIMENSIONS, MM

d	44,450
D	85,001
D1	57,302
D2	74,295
D3	91,592
B	49,213
B1	27,783
B2	21,107
f	6,350
c	19,050
T	1,651
T1	8,001
F	5/16-24

#### WEIGHT, KG

0,948

#### MANUFACTURER

[ASAHI](#)