

## SER 210-30 ASAHI

Insert bearings

TYPE: Ball bearings, Radial insert bearings, Grub screw to inner ring, Cylindrical outer ring, snap ring, Series SER, seals on both side, inch size

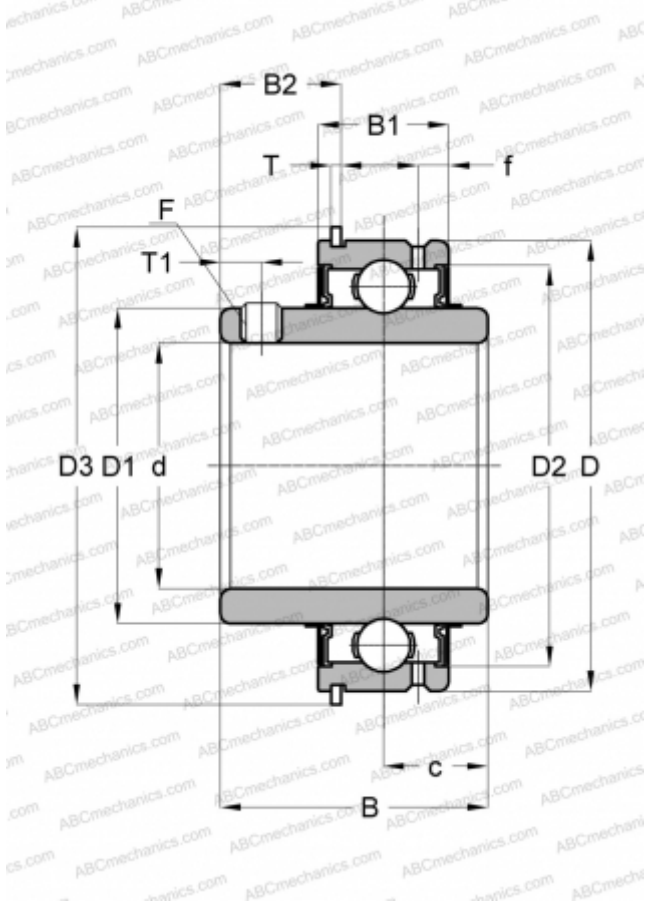

### Technical specification

#### DIMENSIONS, MM

d	47,625
D	90,000
D1	62,992
D2	79,705
D3	96,495
B	51,595
B1	28,575
B2	23,851
f	7,541
c	19,050
T	2,413
T1	8,992
F	3/8-24

#### WEIGHT, KG

1,030

#### MANUFACTURER

[ASAHI](#)