

SER 210-31 ASAHI

Insert bearings

TYPE: Ball bearings, Radial insert bearings, Grub screw to inner ring, Cylindrical outer ring, snap ring, Series SER, seals on both side, inch size

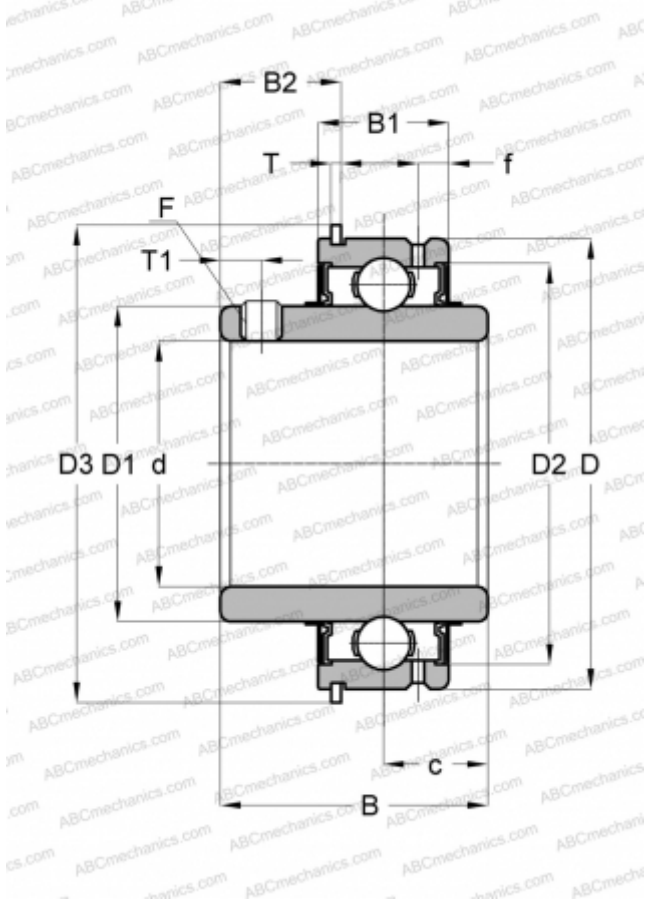

Technical specification

DIMENSIONS, MM

d	49,212
D	90,000
D1	62,992
D2	79,705
D3	96,495
B	51,595
B1	28,575
B2	23,851
f	7,541
c	19,050
T	2,413
T1	8,992
F	3/8-24

WEIGHT, KG

1,030

MANUFACTURER

[ASAHI](#)