

SER 211-35 ASAHI

Insert bearings

TYPE: Ball bearings, Radial insert bearings, Grub screw to inner ring, Cylindrical outer ring, snap ring, Series SER, seals on both side, inch size

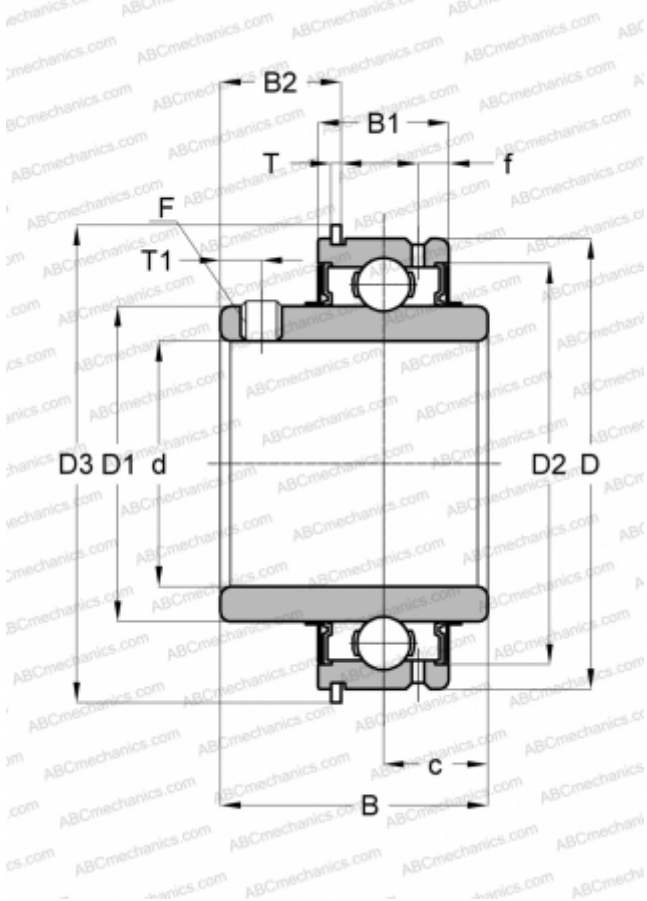

Technical specification

DIMENSIONS, MM

d	55,562
D	100,000
D1	70,002
D2	90,703
D3	106,502
B	55,563
B1	55,563
B2	23,851
f	7,541
c	22,225
T	2,413
T1	8,992
F	3/8-24

WEIGHT, KG

1,211

MANUFACTURER

[ASAHI](#)