

SER 212-38 ASAHI

Insert bearings

TYPE: Ball bearings, Radial insert bearings, Grub screw to inner ring, Cylindrical outer ring, snap ring, Series SER, seals on both side, inch size

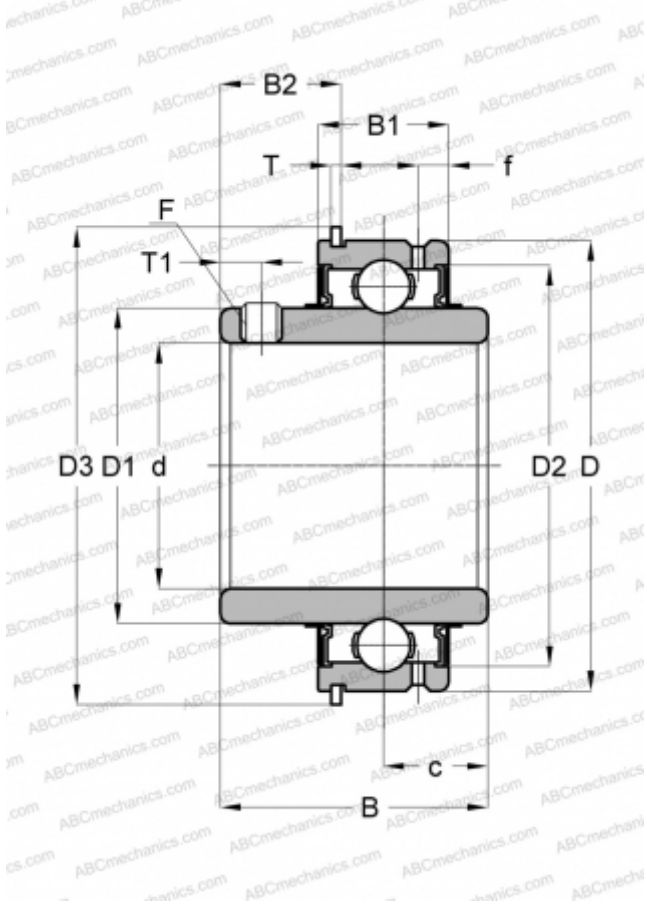

Technical specification

DIMENSIONS, MM

d	60,325
D	110,000
D1	76,987
D2	100,000
D3	116,611
B	65,088
B1	31,750
B2	29,413
f	7,541
c	25,400
T	2,413
T1	10,008
F	3/8-24

WEIGHT, KG

1,678

MANUFACTURER

[ASAHI](#)