

## UK 206 + H2306 ASAHI

Insert bearings

TYPE: Ball bearings, Radial insert bearings, With adapter sleeve, Spherical outer ring, Series UK, seals on both side

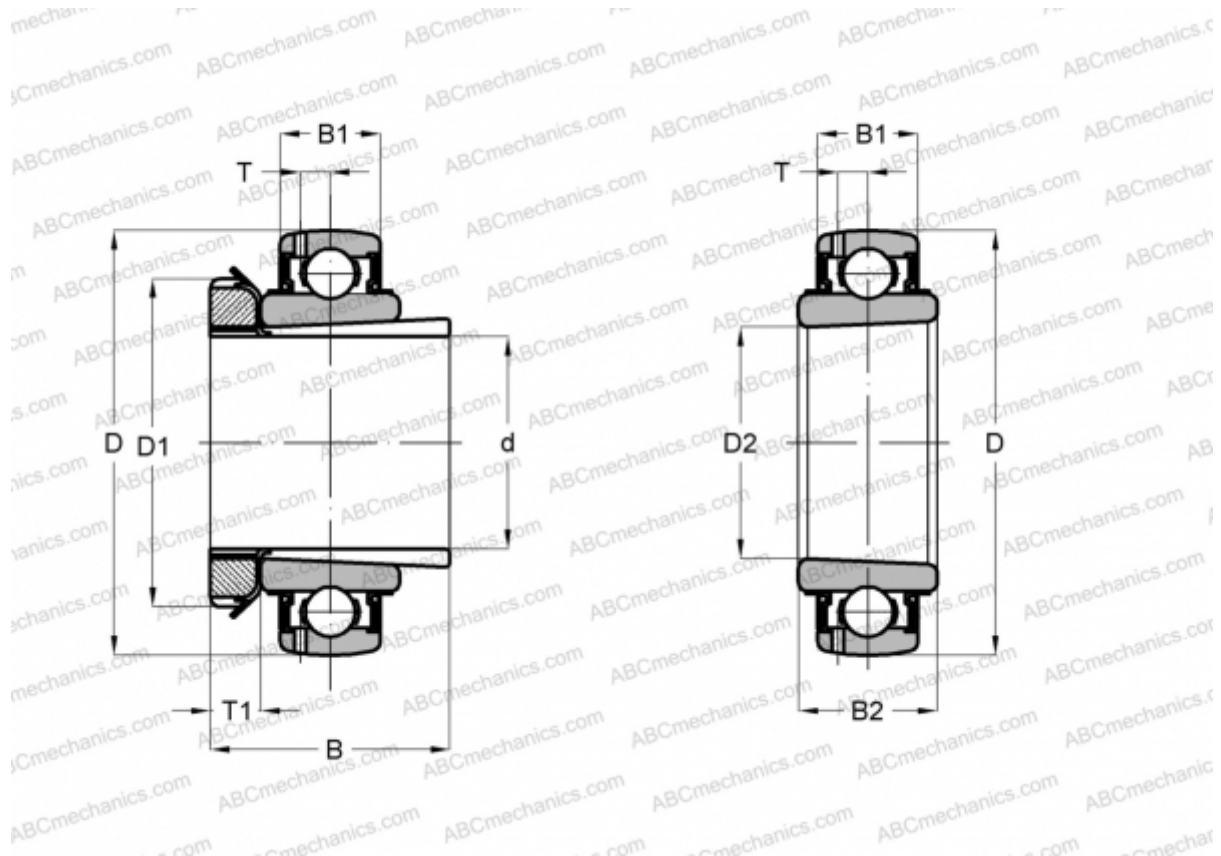

### Technical specification

#### DIMENSIONS, MM

d	25,000
D	62,000
D1	45,000
D2	30,000
B	38,000
B1	19,000
B2	26,000
T	5,100
T1	8,000

**WEIGHT, KG** 0,400

**MANUFACTURER** [ASAHI](#)