

UK 213 + H2313 ASAHI

Insert bearings

TYPE: Ball bearings, Radial insert bearings, With adapter sleeve, Spherical outer ring, Series UK, seals on both side

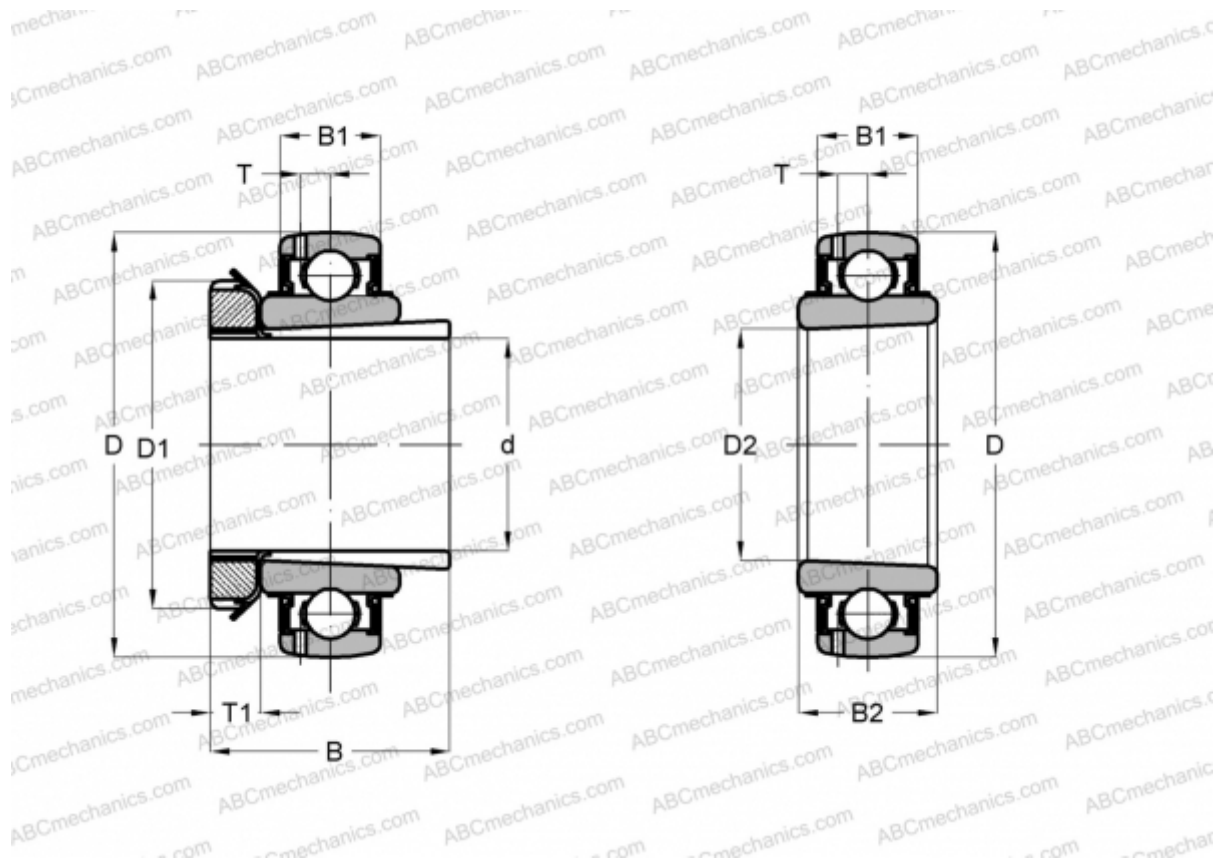

Technical specification

DIMENSIONS, MM

d	60,000
D	120,000
D1	85,000
D2	65,000
B	65,000
B1	27,000
B2	38,000
T	8,300
T1	14,000

WEIGHT, KG 1,820

MANUFACTURER [ASAHI](#)