

## UK 216 + H2316 ASAHI

Insert bearings

TYPE: Ball bearings, Radial insert bearings, With adapter sleeve, Spherical outer ring, Series UK, seals on both side

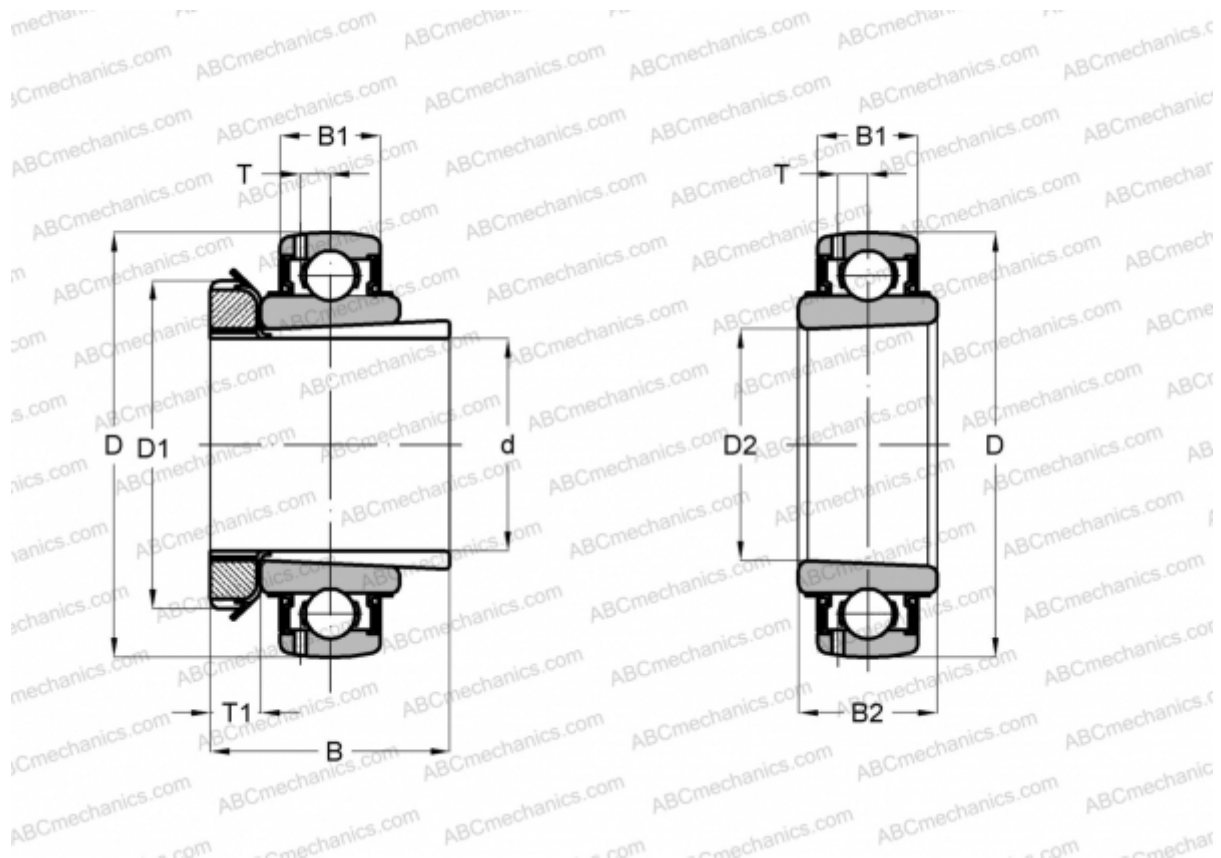

### Technical specification

#### DIMENSIONS, MM

d	70,000
D	140,000
D1	105,000
D2	80,000
B	78,000
B1	32,000
B2	44,000
T	9,600
T1	17,000

**WEIGHT, KG** 3,270

**MANUFACTURER** [ASAHI](#)