

UK 218 + H2318 ASAHI

Insert bearings

TYPE: Ball bearings, Radial insert bearings, With adapter sleeve, Spherical outer ring, Series UK, seals on both side

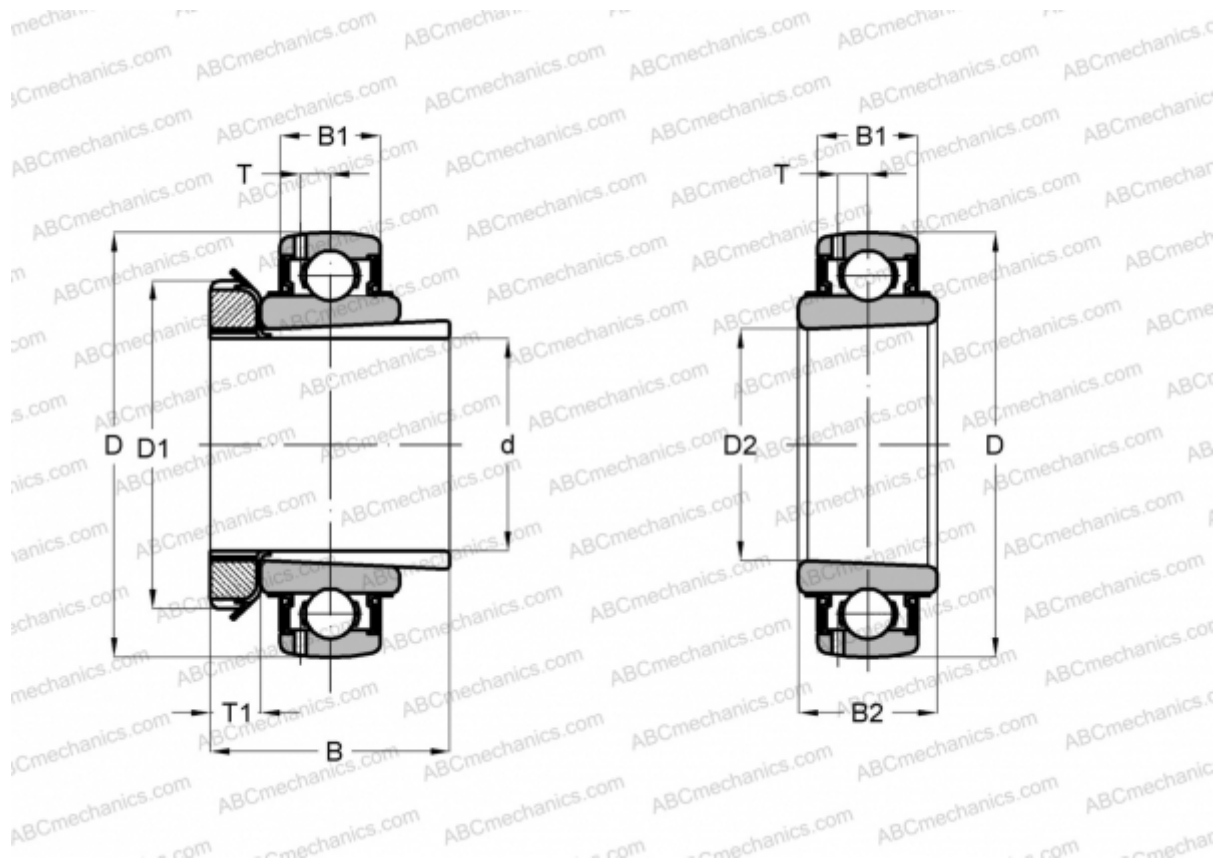

Technical specification

DIMENSIONS, MM

d	80,000
D	160,000
D1	120,000
D2	90,000
B	86,000
B1	36,000
B2	49,000
T	11,100
T1	18,000

WEIGHT, KG 4,680

MANUFACTURER [ASAHI](#)