

UK 305 + H2305 ASAHI

Insert bearings

TYPE: Ball bearings, Radial insert bearings, With adapter sleeve, Spherical outer ring, Series UK, seals on both side

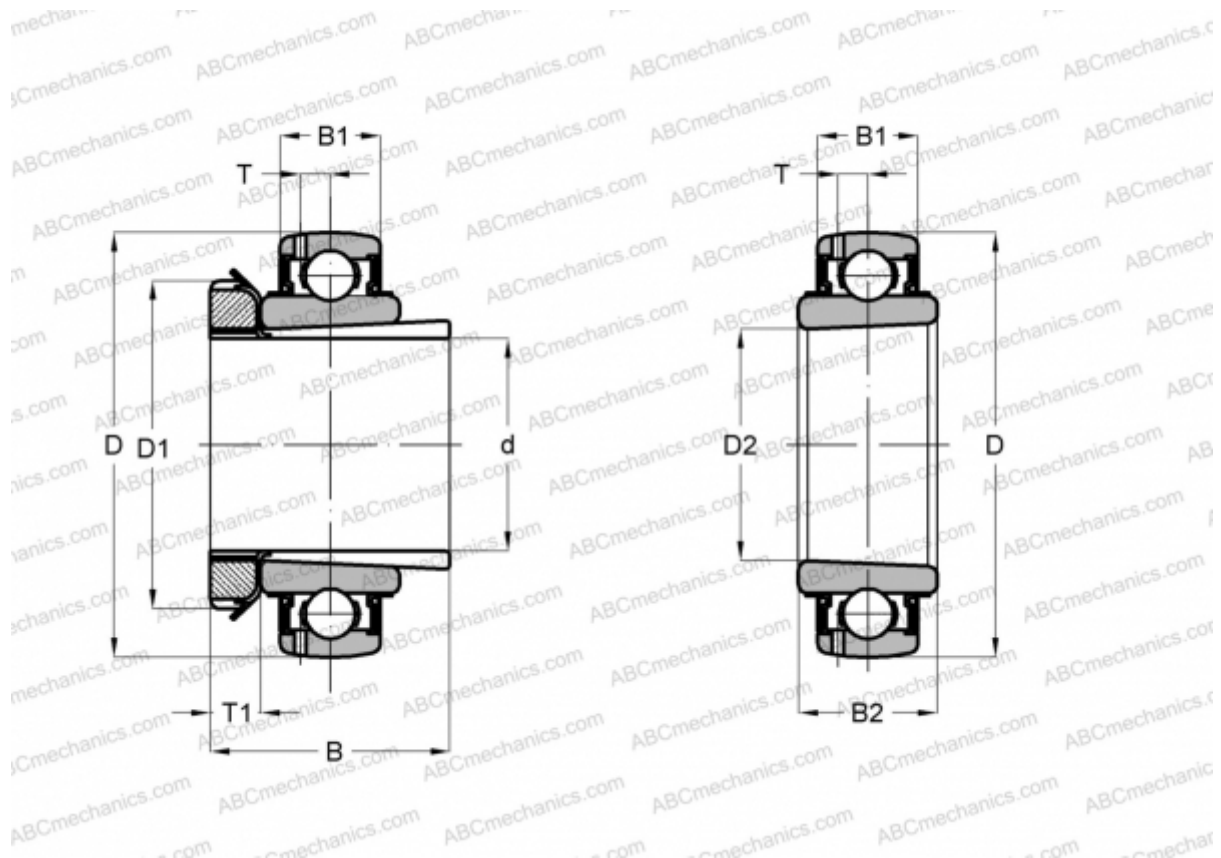

Technical specification

DIMENSIONS, MM

d	20,000
D	62,000
D1	38,000
D2	25,000
B	35,000
B1	21,000
B2	26,000
T	6,100
T1	8,000

WEIGHT, KG 0,480

MANUFACTURER [ASAHI](#)