

## UK 307 + H2307 ASAHI

Insert bearings

TYPE: Ball bearings, Radial insert bearings, With adapter sleeve, Spherical outer ring, Series UK, seals on both side

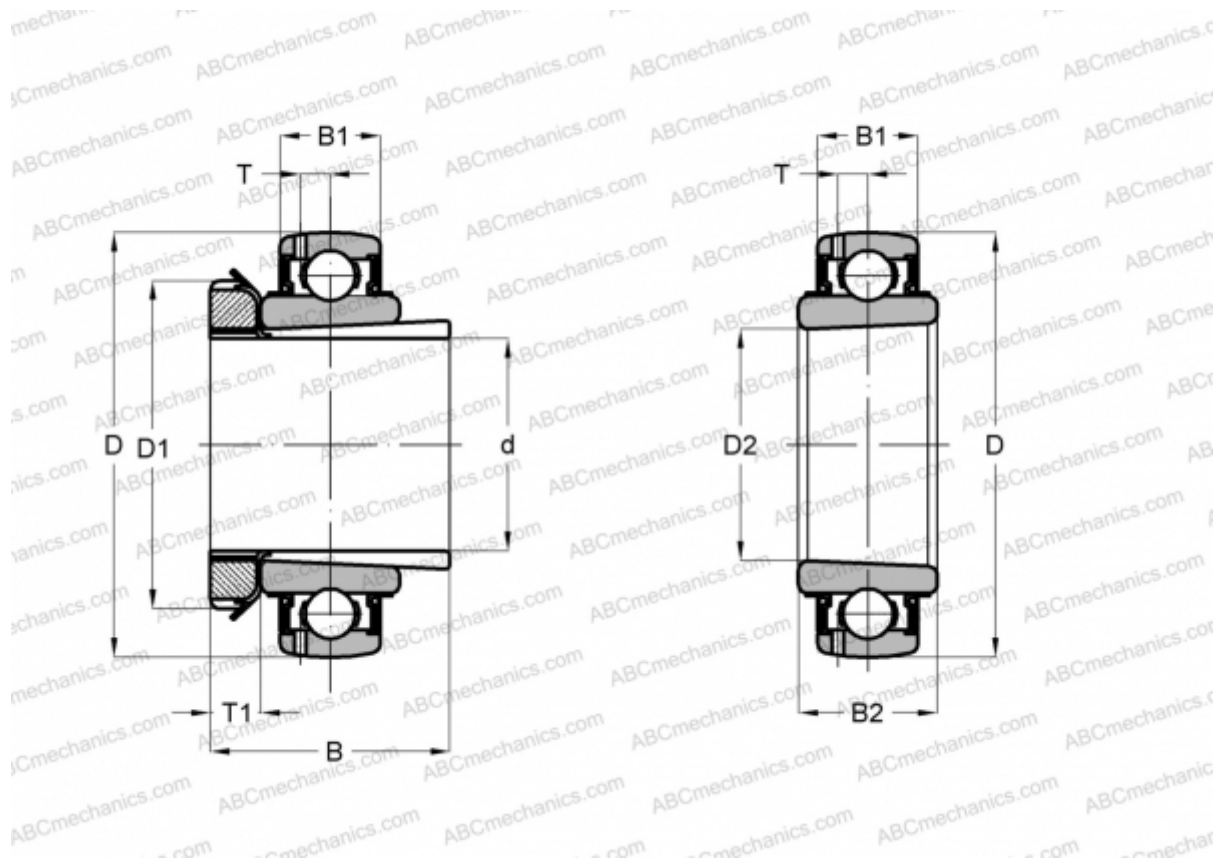

### Technical specification

#### DIMENSIONS, MM

d	30,000
D	80,000
D1	52,000
D2	35,000
B	43,000
B1	25,000
B2	31,000
T	7,400
T1	9,000

**WEIGHT, KG** 0,740

**MANUFACTURER** [ASAHI](#)