

## UK 313 + H2313 ASAHI

Insert bearings

TYPE: Ball bearings, Radial insert bearings, With adapter sleeve, Spherical outer ring, Series UK, seals on both side

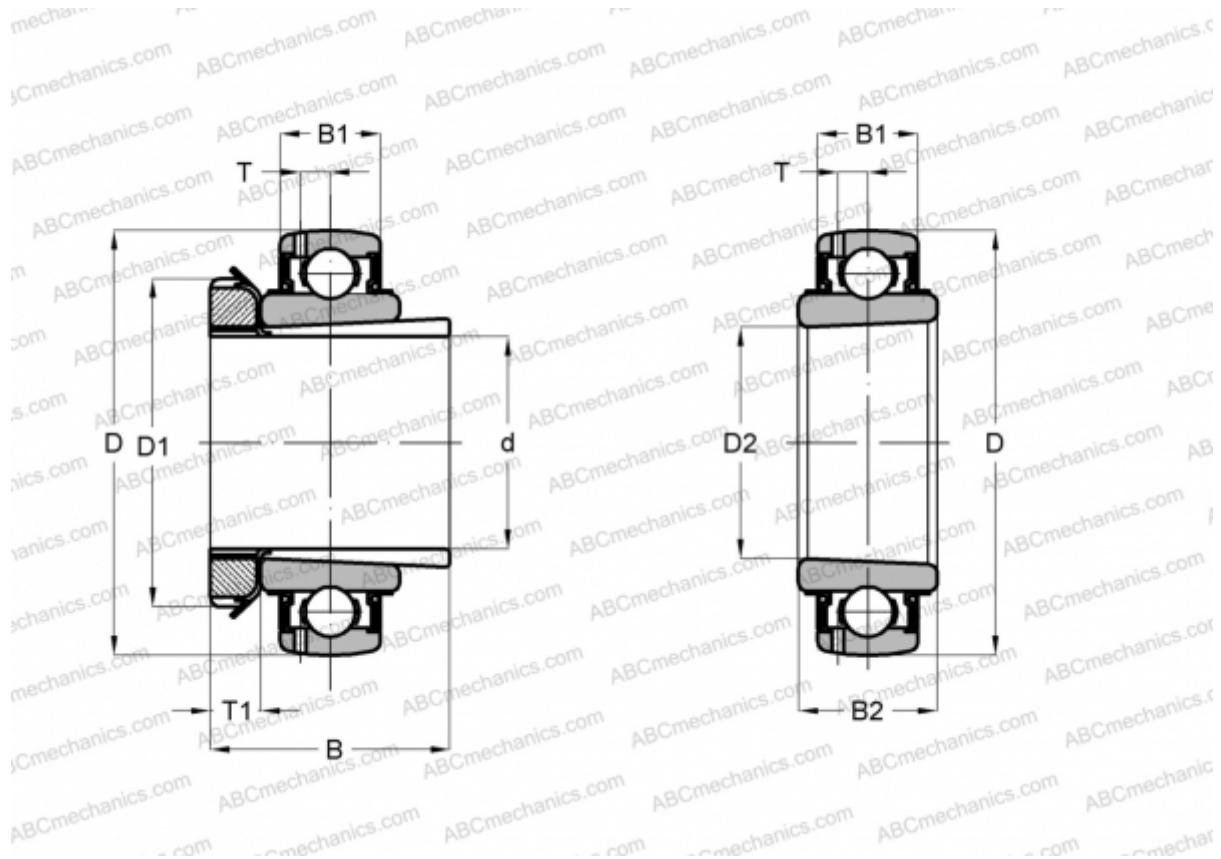

### Technical specification

#### DIMENSIONS, MM

d	60,000
D	140,000
D1	85,000
D2	65,000
B	65,000
B1	38,000
B2	48,000
T	12,200
T1	14,000

**WEIGHT, KG** 3,070

**MANUFACTURER** [ASAHI](#)