

UK 318 + H2318 ASAHI

Insert bearings

TYPE: Ball bearings, Radial insert bearings, With adapter sleeve, Spherical outer ring, Series UK, seals on both side

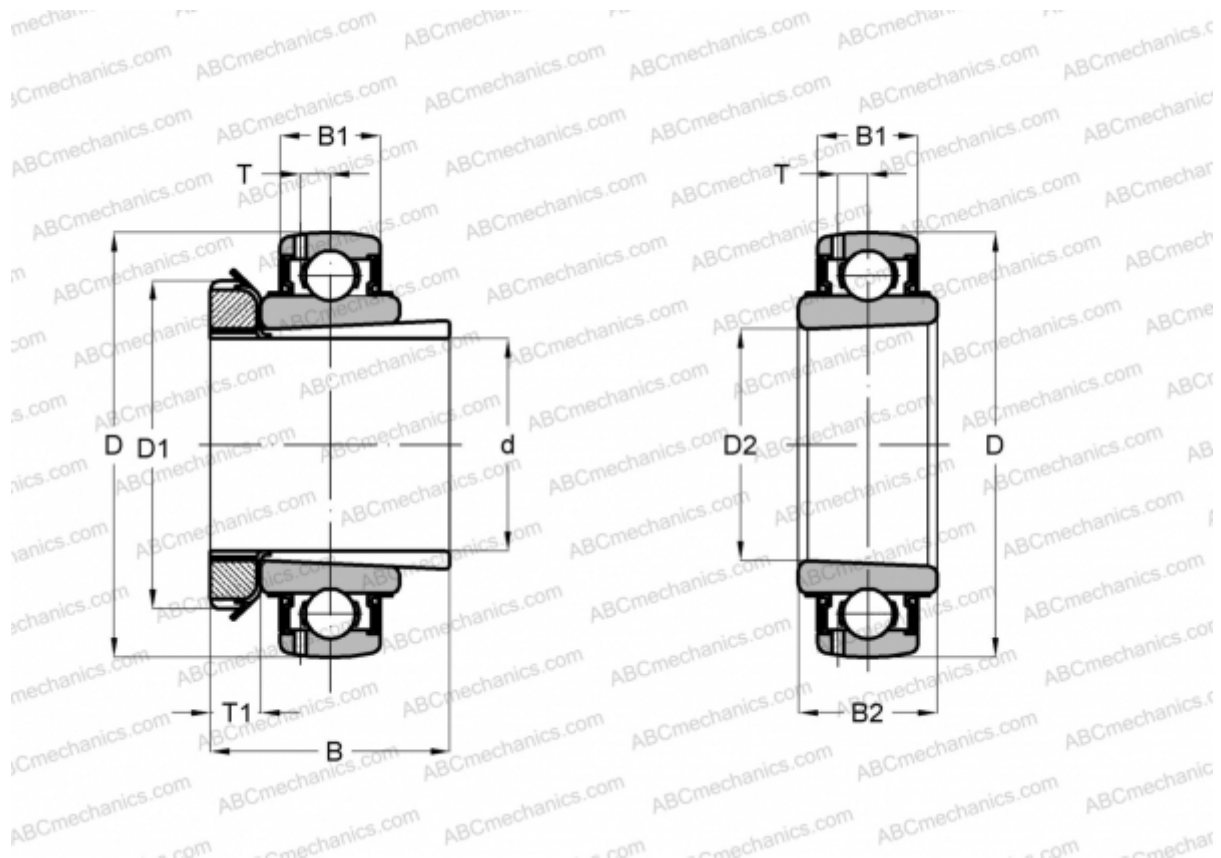

Technical specification

DIMENSIONS, MM

d	80,000
D	190,000
D1	120,000
D2	90,000
B	86,000
B1	48,000
B2	63,000
T	15,900
T1	18,000

WEIGHT, KG 7,520

MANUFACTURER [ASAHI](#)