

## UK 326 + H2326 ASAHI

Insert bearings

TYPE: Ball bearings, Radial insert bearings, With adapter sleeve, Spherical outer ring, Series UK, seals on both side

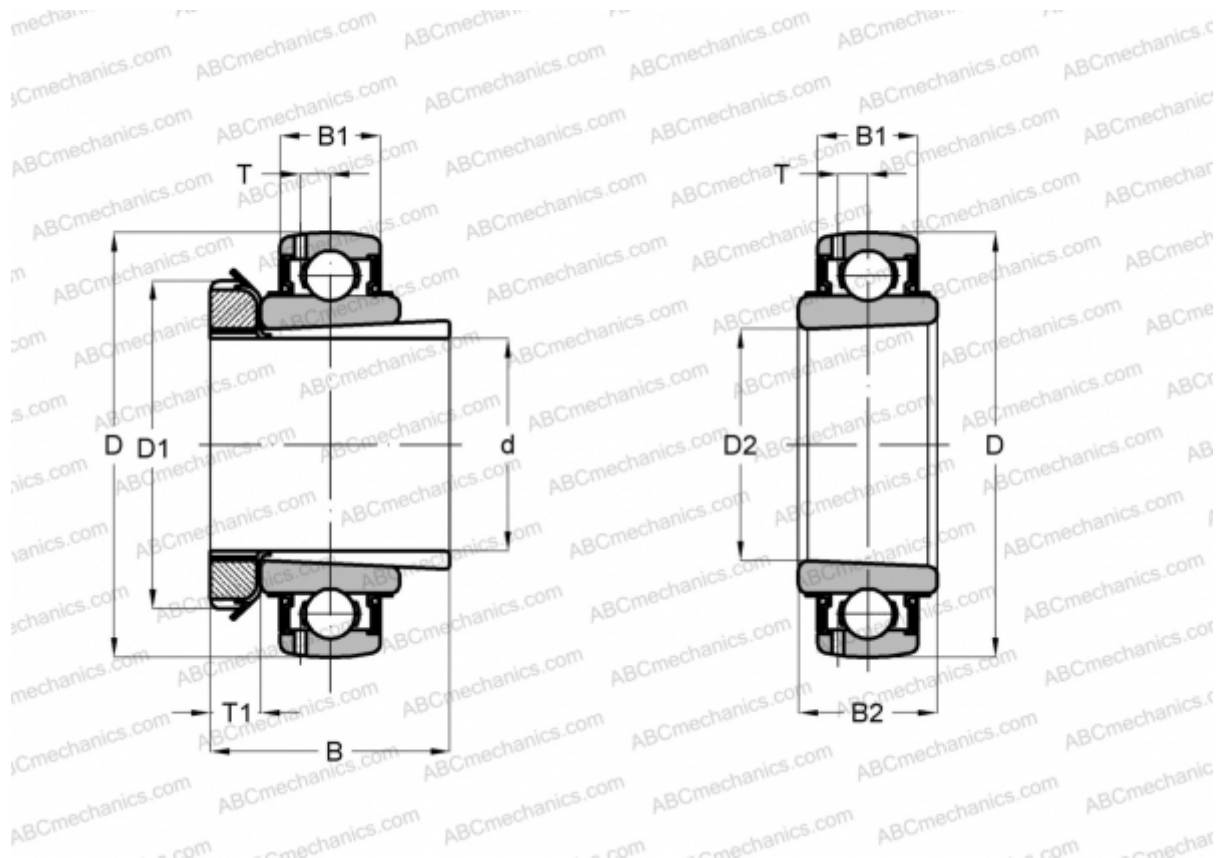

### Technical specification

#### DIMENSIONS, MM

d	115,000
D	280,000
D1	165,000
D2	130,000
B	121,000
B1	68,000
B2	92,000
T	23,000
T1	23,000

**WEIGHT, KG** 23,300

**MANUFACTURER** [ASAHI](#)