

## UK 328 + H2328 ASAHI

Insert bearings

TYPE: Ball bearings, Radial insert bearings, With adapter sleeve, Spherical outer ring, Series UK, seals on both side

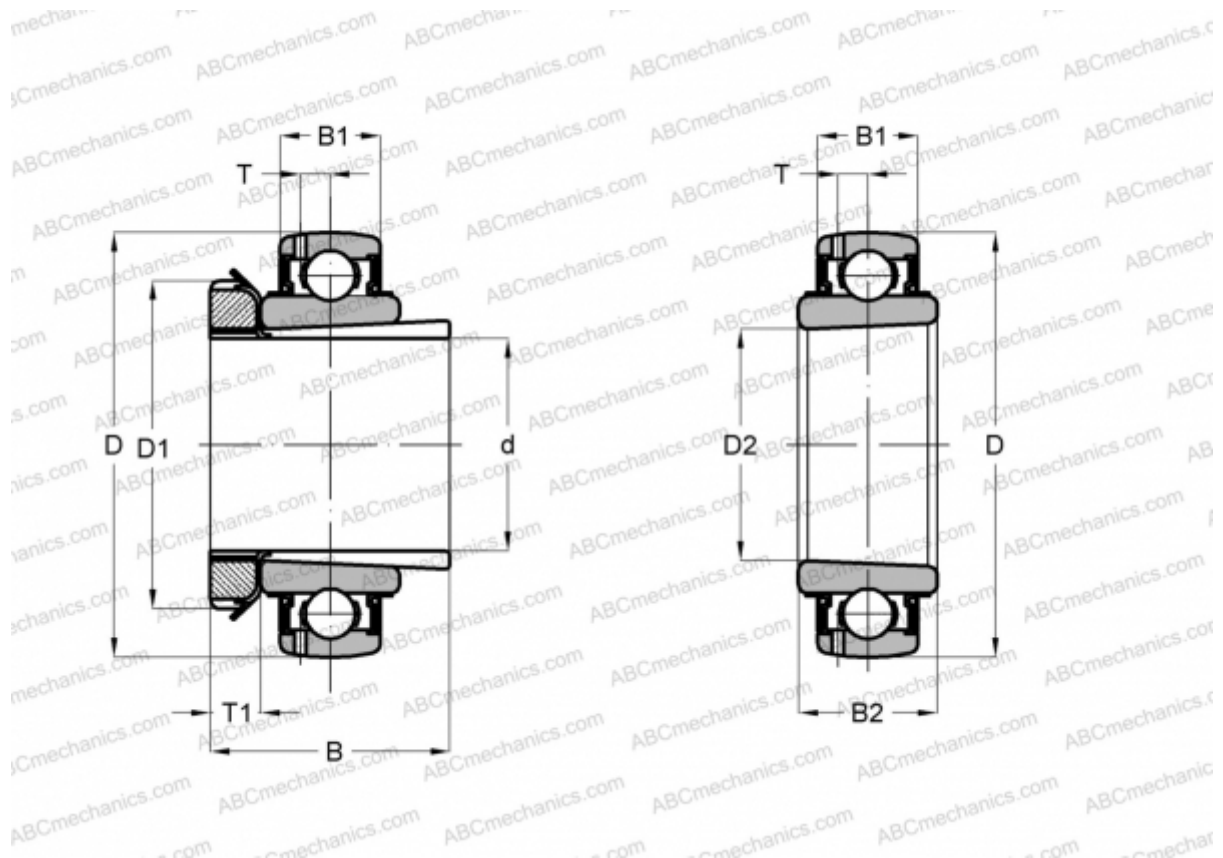

### Technical specification

#### DIMENSIONS, MM

d	125,000
D	300,000
D1	180,000
D2	140,000
B	131,000
B1	73,000
B2	98,000
T	25,000
T1	24,000

**WEIGHT, KG** 28,800

**MANUFACTURER** [ASAHI](#)