

UK 205 + HE2305 ASAHI

Insert bearings

TYPE: Ball bearings, Radial insert bearings, With adapter sleeve, Spherical outer ring, Series UK, seals on both side, inch size

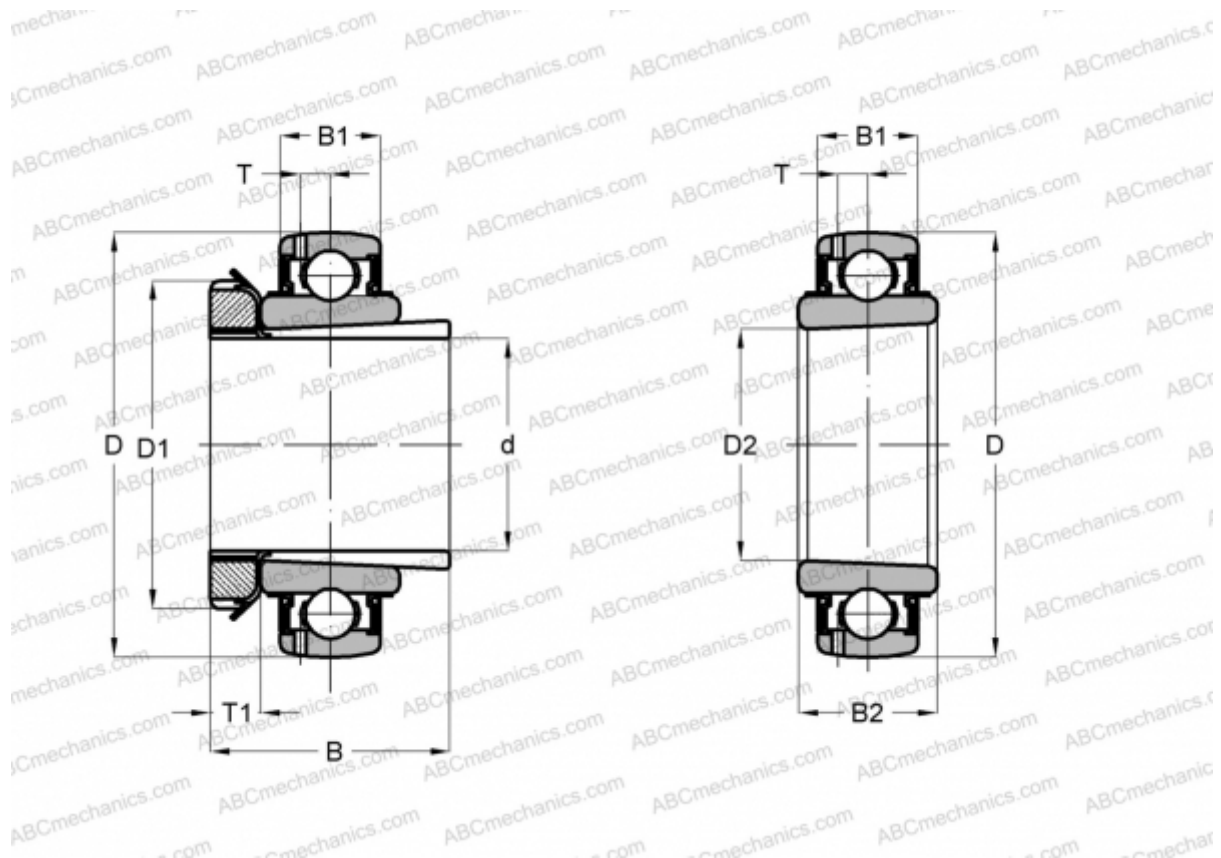

Technical specification

DIMENSIONS, MM

d	19,050
D	51,999
D1	37,998
D2	25,001
B	35,001
B1	16,993
B2	23,012
T	4,496
T1	8,001

WEIGHT, KG 0,240

MANUFACTURER [ASAHI](#)