

UK 209 + HE2309 ASAHI

Insert bearings

TYPE: Ball bearings, Radial insert bearings, With adapter sleeve, Spherical outer ring, Series UK, seals on both side, inch size

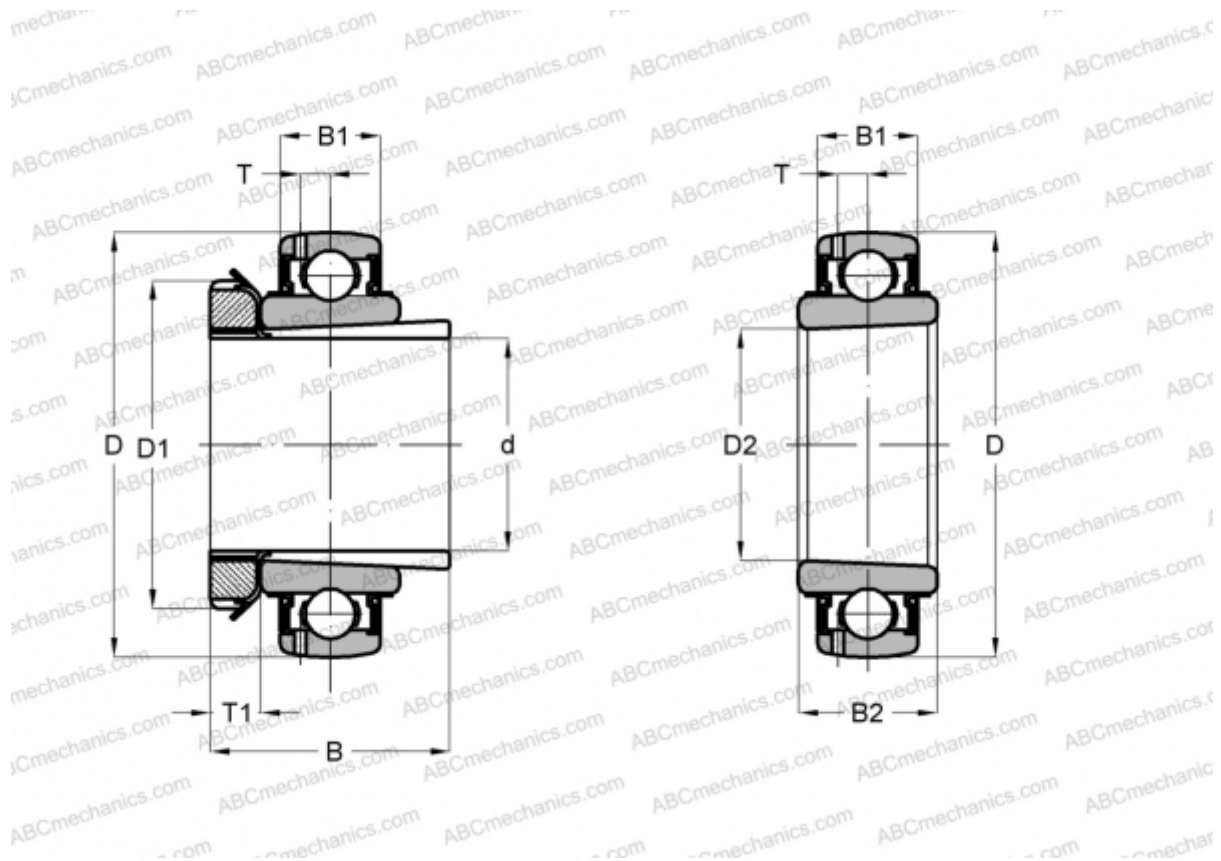

Technical specification

DIMENSIONS, MM

d	38,100
D	85,001
D1	64,999
D2	45,001
B	50,013
B1	21,996
B2	29,997
T	6,502
T1	10,998

WEIGHT, KG 0,771

MANUFACTURER [ASAHI](#)