

UK 309 + HE2309 ASAHI

Insert bearings

TYPE: Ball bearings, Radial insert bearings, With adapter sleeve, Spherical outer ring, Series UK, seals on both side, inch size

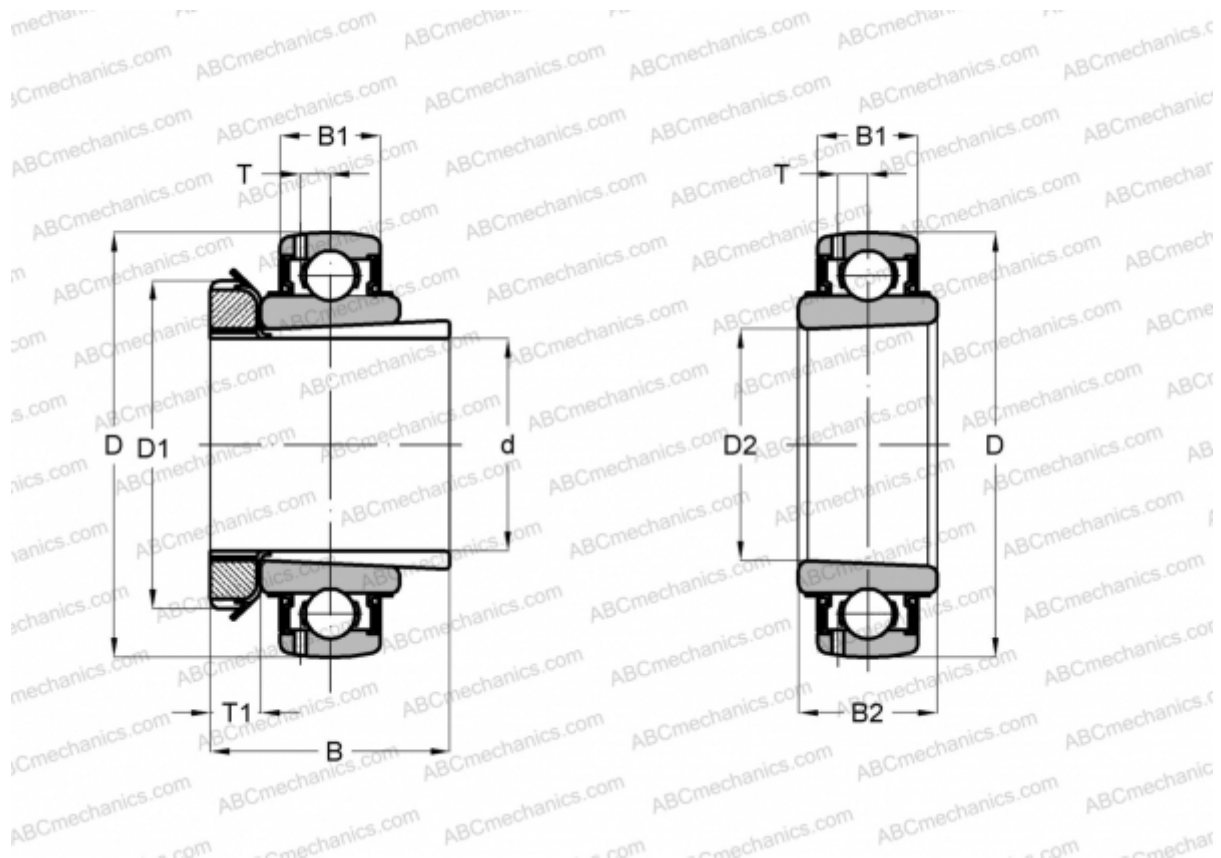

Technical specification

DIMENSIONS, MM

d	38,100
D	100,000
D1	64,999
D2	45,001
B	50,013
B1	29,997
B2	37,008
T	8,992
T1	10,998

WEIGHT, KG 1,311

MANUFACTURER [ASAHI](#)