

UK 310 + HE2310 ASAHI

Insert bearings

TYPE: Ball bearings, Radial insert bearings, With adapter sleeve, Spherical outer ring, Series UK, seals on both side, inch size

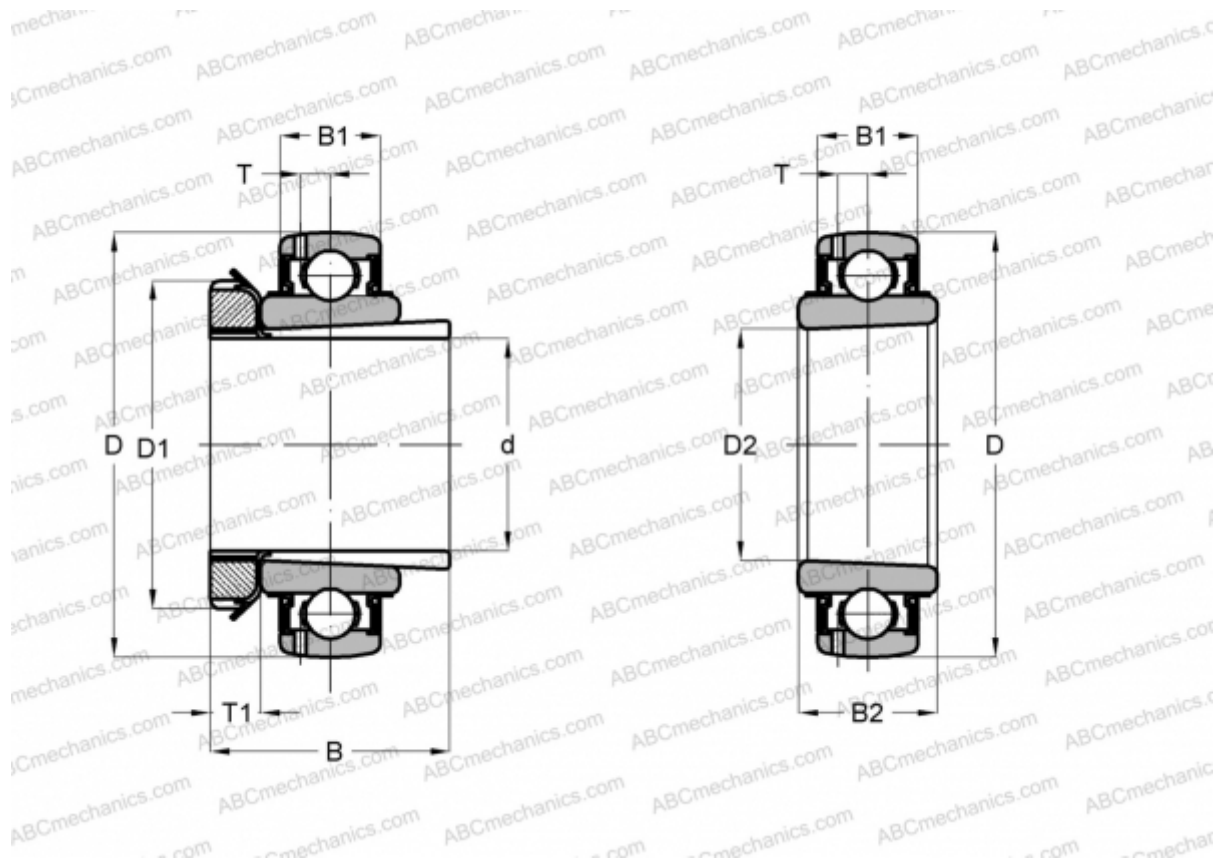

Technical specification

DIMENSIONS, MM

d	44,450
D	110,000
D1	70,002
D2	50,000
B	54,991
B1	32,004
B2	40,005
T	10,008
T1	11,989

WEIGHT, KG 1,678

MANUFACTURER [ASAHI](#)