

UK 311 + HE2311 ASAHI

Insert bearings

TYPE: Ball bearings, Radial insert bearings, With adapter sleeve, Spherical outer ring, Series UK, seals on both side, inch size

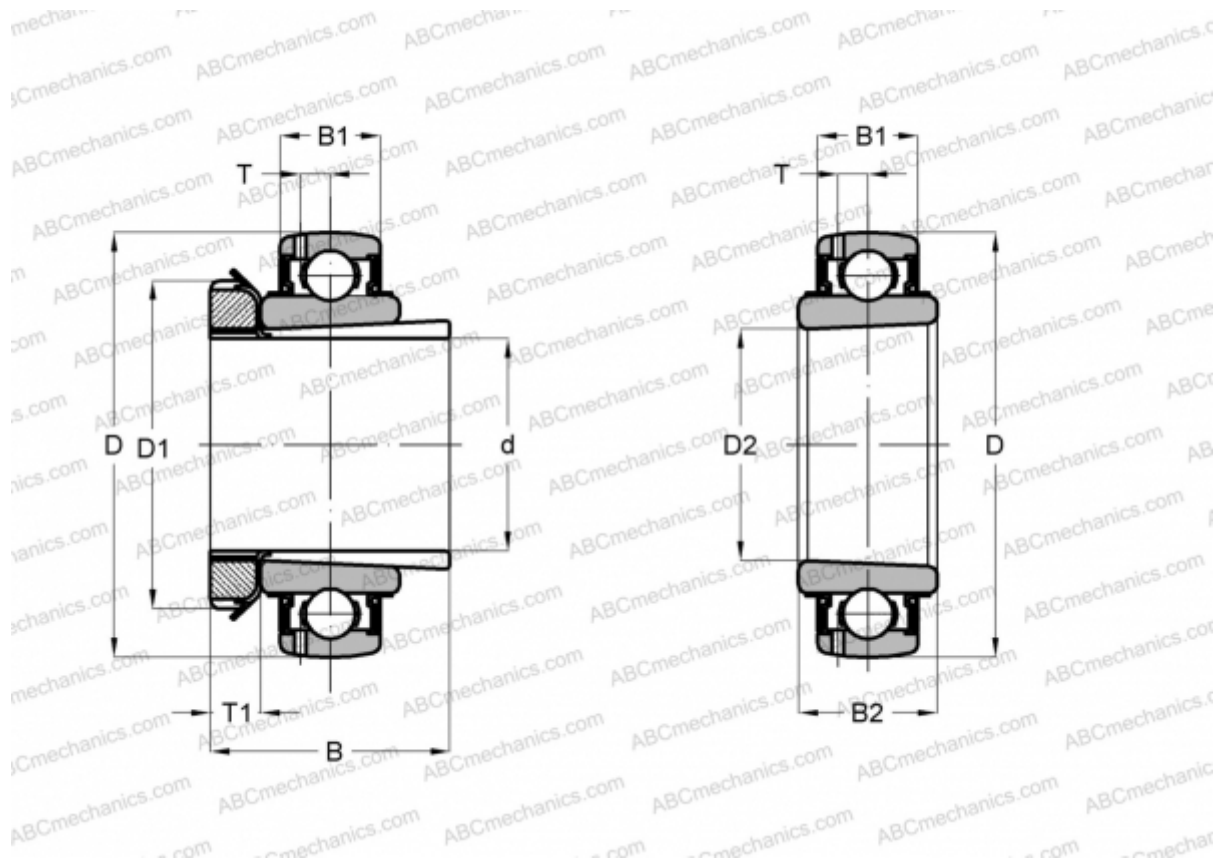

Technical specification

DIMENSIONS, MM

d	50,800
D	120,000
D1	75,006
D2	55,001
B	59,004
B1	34,011
B2	43,002
T	10,693
T1	11,989

WEIGHT, KG 2,059

MANUFACTURER [ASAHI](#)