

UK 313 + HS2313 ASAHI

Insert bearings

TYPE: Ball bearings, Radial insert bearings, With adapter sleeve, Spherical outer ring, Series UK, seals on both side, inch size

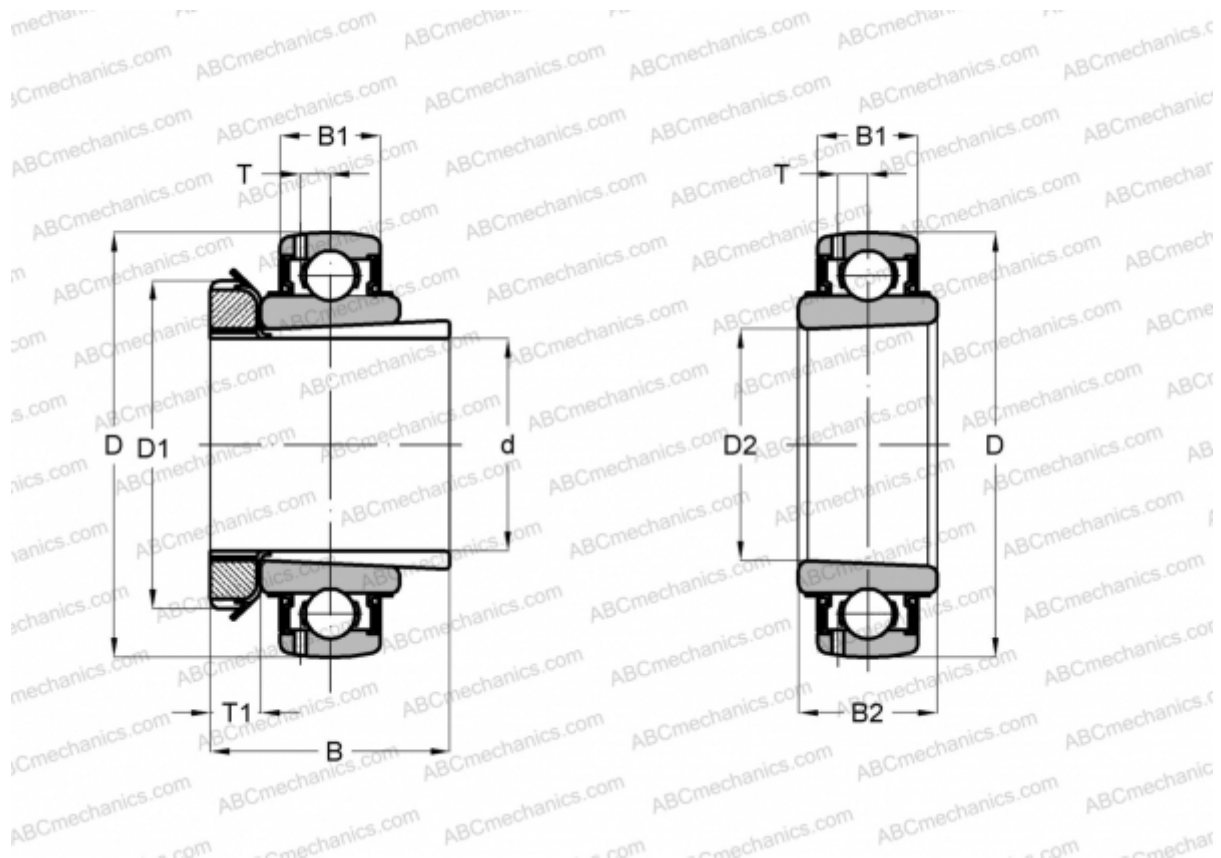

Technical specification

DIMENSIONS, MM

d	60,325
D	140,000
D1	84,988
D2	65,001
B	64,999
B1	37,998
B2	48,006
T	12,192
T1	13,995

WEIGHT, KG 3,071

MANUFACTURER [ASAHI](#)