

UK 317 + HE2317 ASAHI

Insert bearings

TYPE: Ball bearings, Radial insert bearings, With adapter sleeve, Spherical outer ring, Series UK, seals on both side, inch size

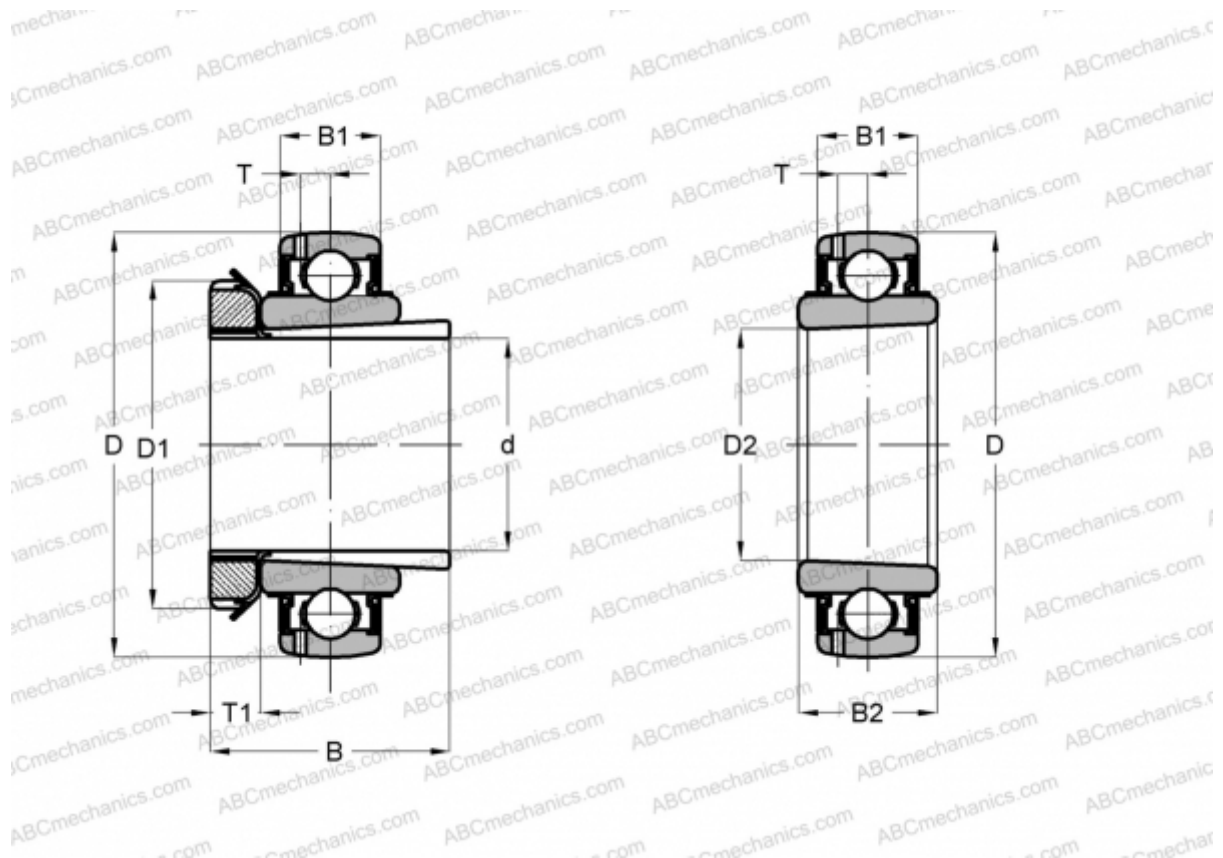

Technical specification

DIMENSIONS, MM

d	76,200
D	180,000
D1	110,007
D2	85,001
B	81,991
B1	45,999
B2	59,995
T	15,011
T1	18,009

WEIGHT, KG 6,559

MANUFACTURER [ASAHI](#)