

UK X06 + H2306 ASAHI

Insert bearings

TYPE: Ball bearings, Radial insert bearings, With adapter sleeve, Spherical outer ring, Series UK X, seals on both side

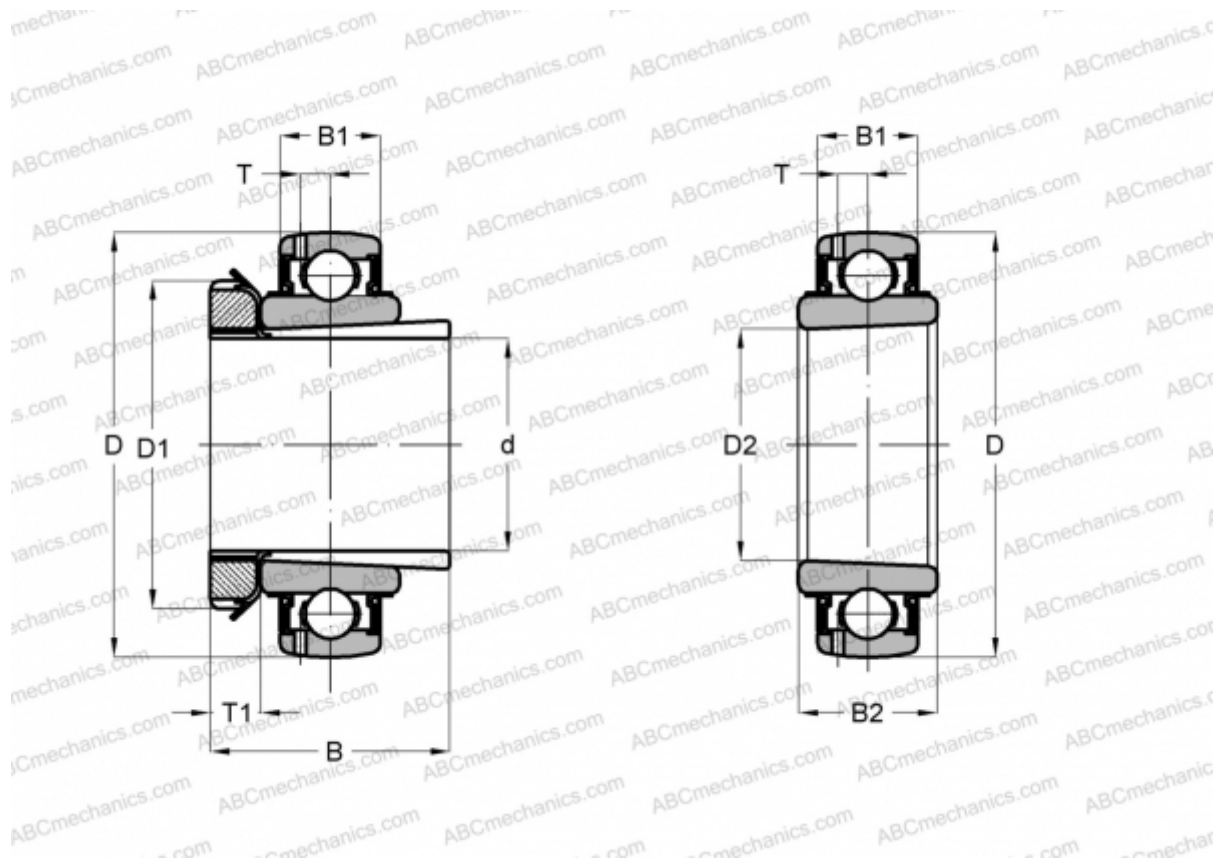

Technical specification

DIMENSIONS, MM

d	25,000
D	72,000
D1	45,000
D2	30,000
B	38,000
B1	20,000
B2	27,000
T	5,800
T1	8,000

WEIGHT, KG 0,540

MANUFACTURER [ASAHI](#)