

## UK X07 + H2307 ASAHI

Insert bearings

TYPE: Ball bearings, Radial insert bearings, With adapter sleeve, Spherical outer ring, Series UK X, seals on both side

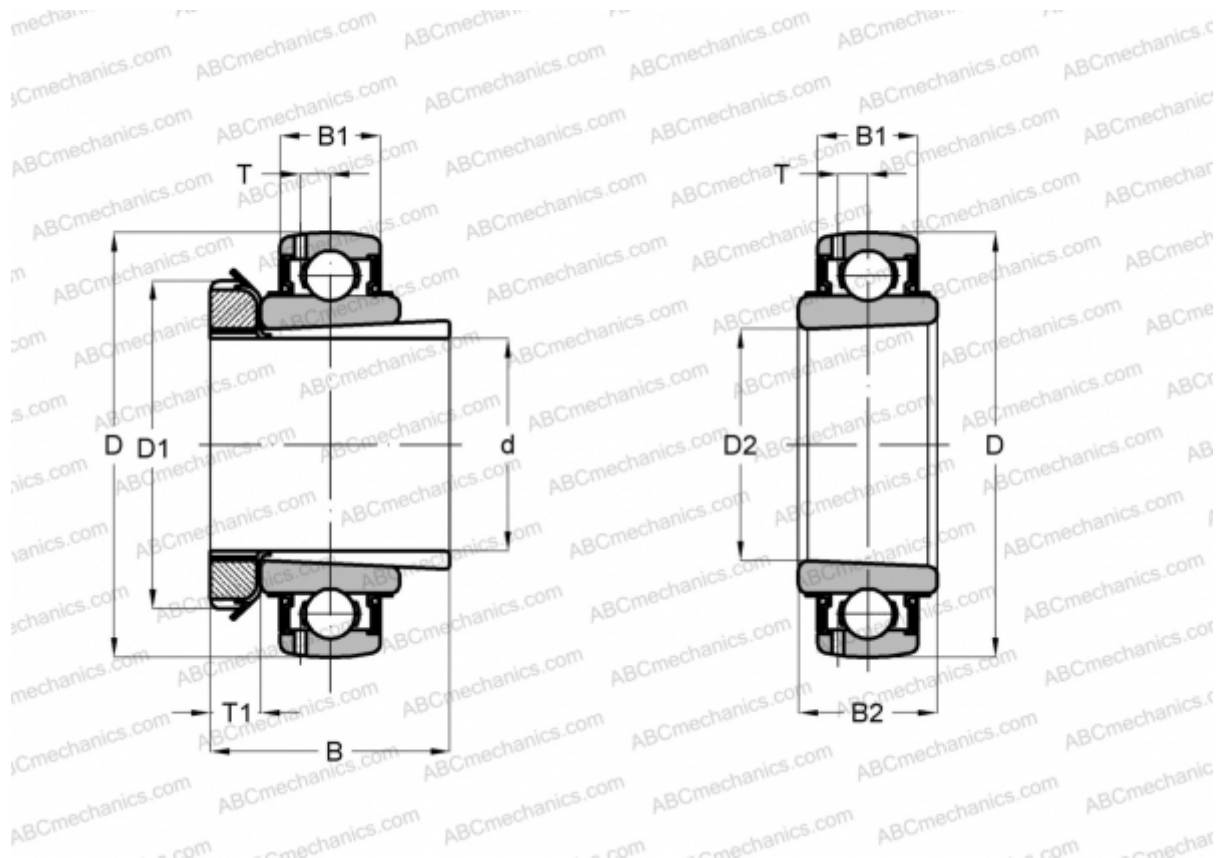

### Technical specification

#### DIMENSIONS, MM

d	30,000
D	80,000
D1	52,000
D2	35,000
B	43,000
B1	21,000
B2	29,000
T	6,200
T1	9,000

**WEIGHT, KG** 0,700

**MANUFACTURER** [ASAHI](#)