

## UK X08 + H2308 ASAHI

Insert bearings

TYPE: Ball bearings, Radial insert bearings, With adapter sleeve, Spherical outer ring, Series UK X, seals on both side

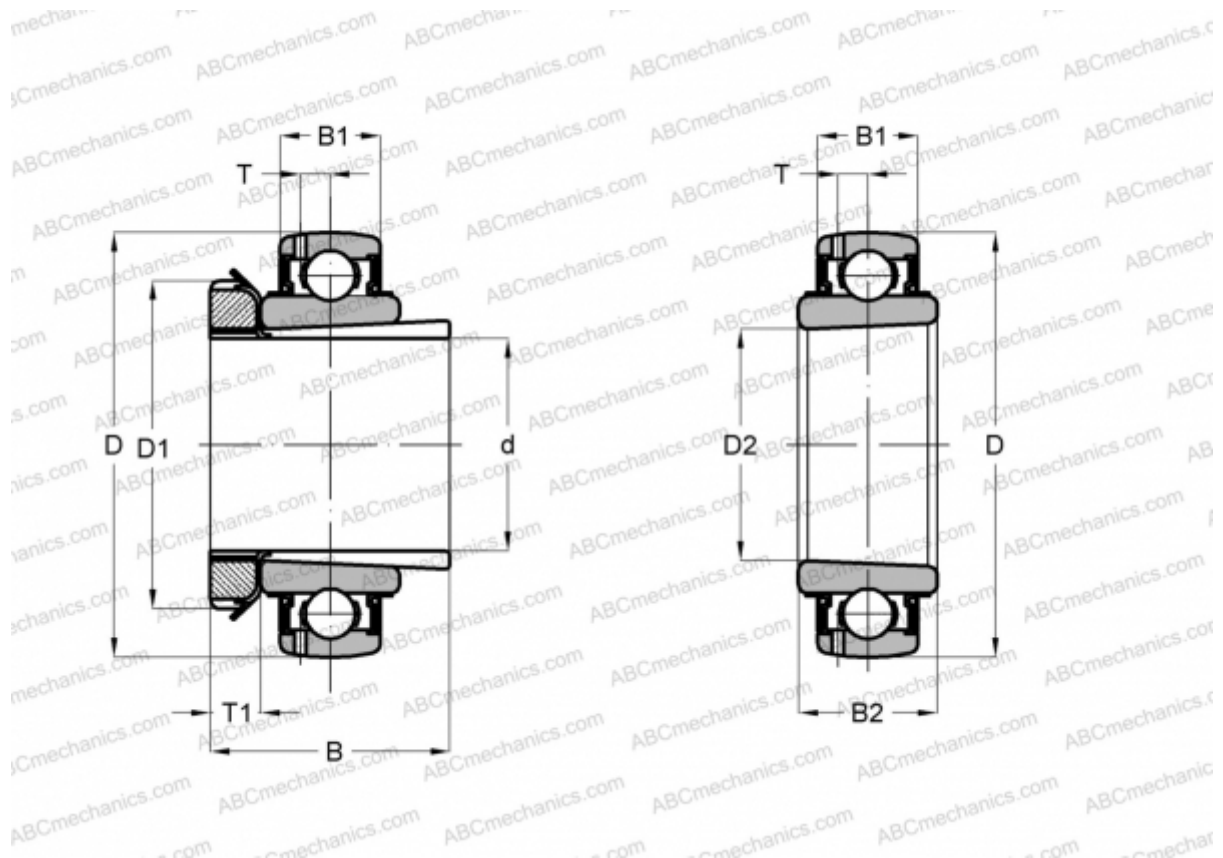

### Technical specification

#### DIMENSIONS, MM

d	35,000
D	85,000
D1	58,000
D2	40,000
B	46,000
B1	22,000
B2	30,000
T	6,500
T1	10,000

**WEIGHT, KG** 0,810

**MANUFACTURER** [ASAHI](#)