

UK X10 + H2310 ASAHI

Insert bearings

TYPE: Ball bearings, Radial insert bearings, With adapter sleeve, Spherical outer ring, Series UK X, seals on both side

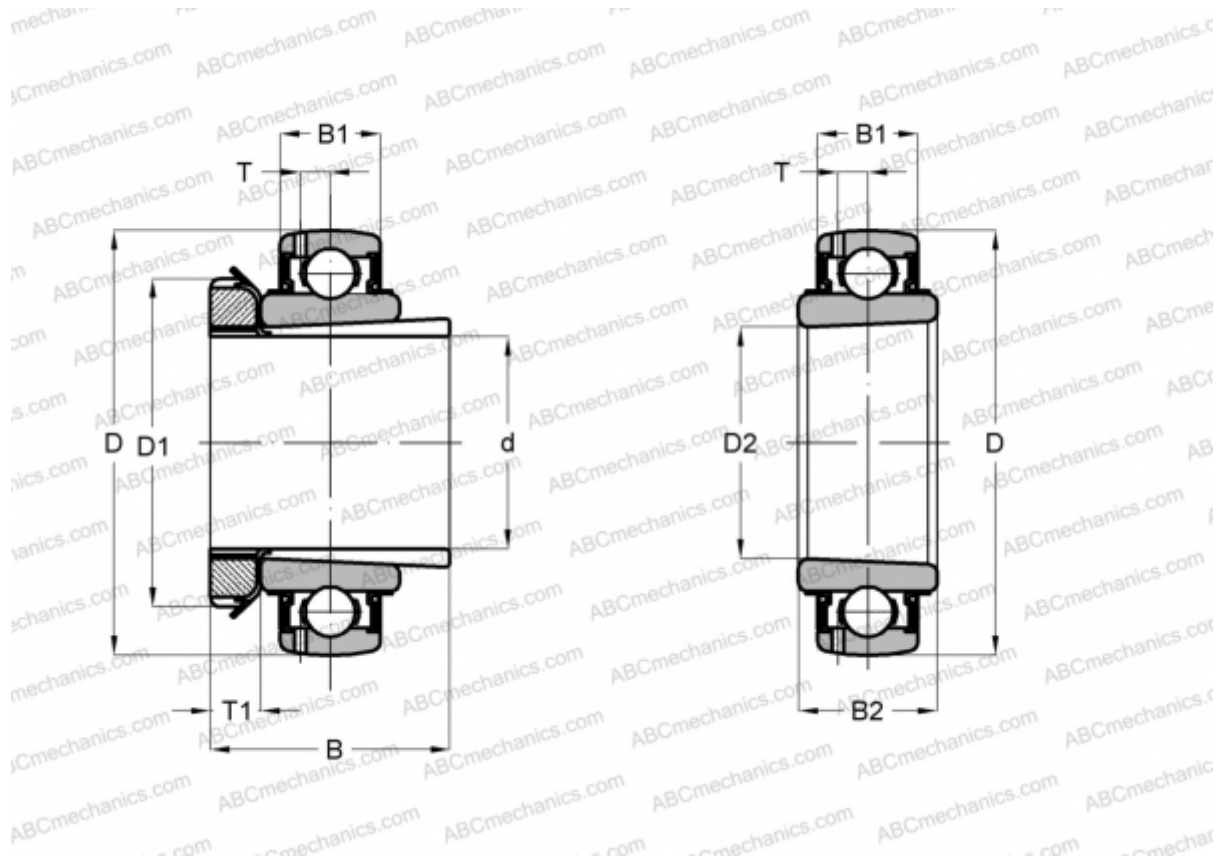

Technical specification

DIMENSIONS, MM

d	45,000
D	100,000
D1	70,000
D2	50,000
B	55,000
B1	24,000
B2	33,000
T	7,300
T1	12,000

WEIGHT, KG 1,220

MANUFACTURER [ASAHI](#)