

UK X12 + H2312 ASAHI

Insert bearings

TYPE: Ball bearings, Radial insert bearings, With adapter sleeve, Spherical outer ring, Series UK X, seals on both side

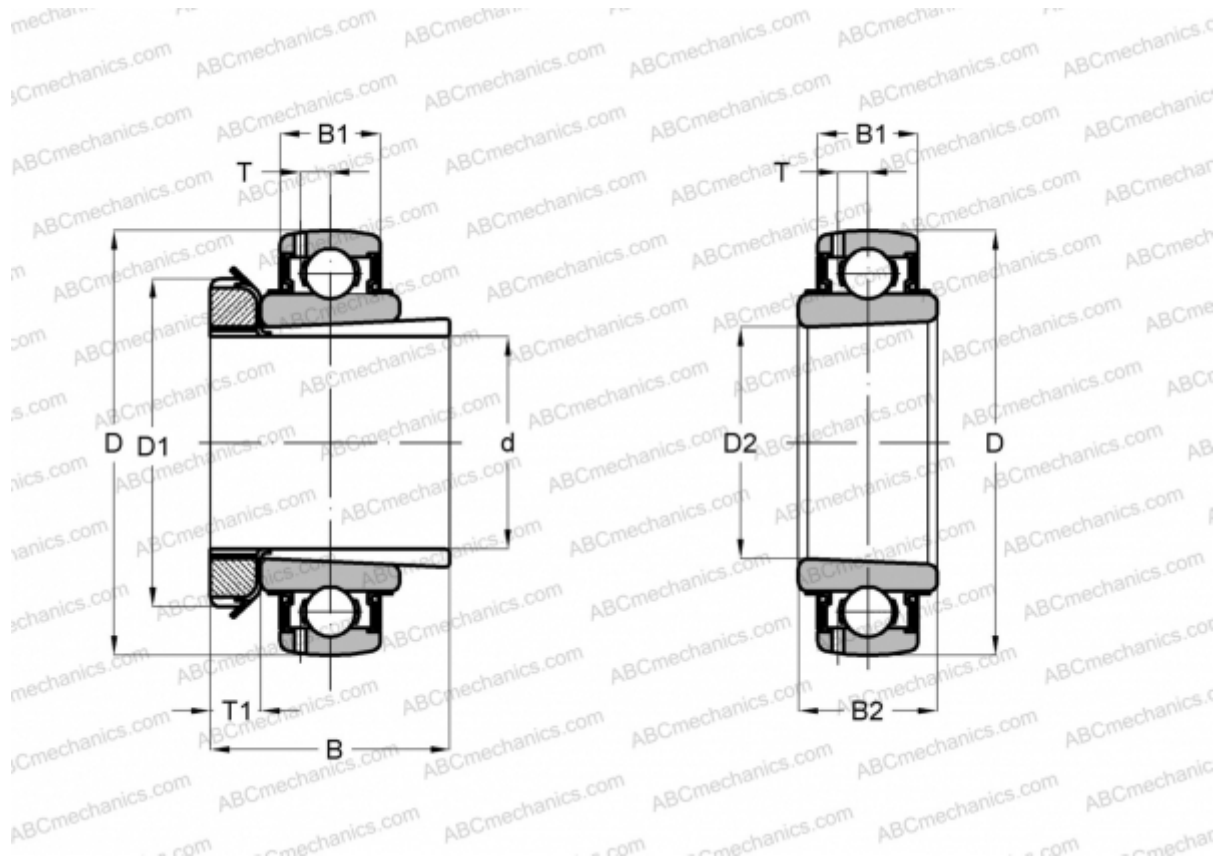

Technical specification

DIMENSIONS, MM

d	55,000
D	120,000
D1	80,000
D2	60,000
B	62,000
B1	27,000
B2	38,000
T	8,300
T1	13,000

WEIGHT, KG 1,890

MANUFACTURER [ASAHI](#)