

UK X15 + H2315 ASAHI

Insert bearings

TYPE: Ball bearings, Radial insert bearings, With adapter sleeve, Spherical outer ring, Series UK X, seals on both side

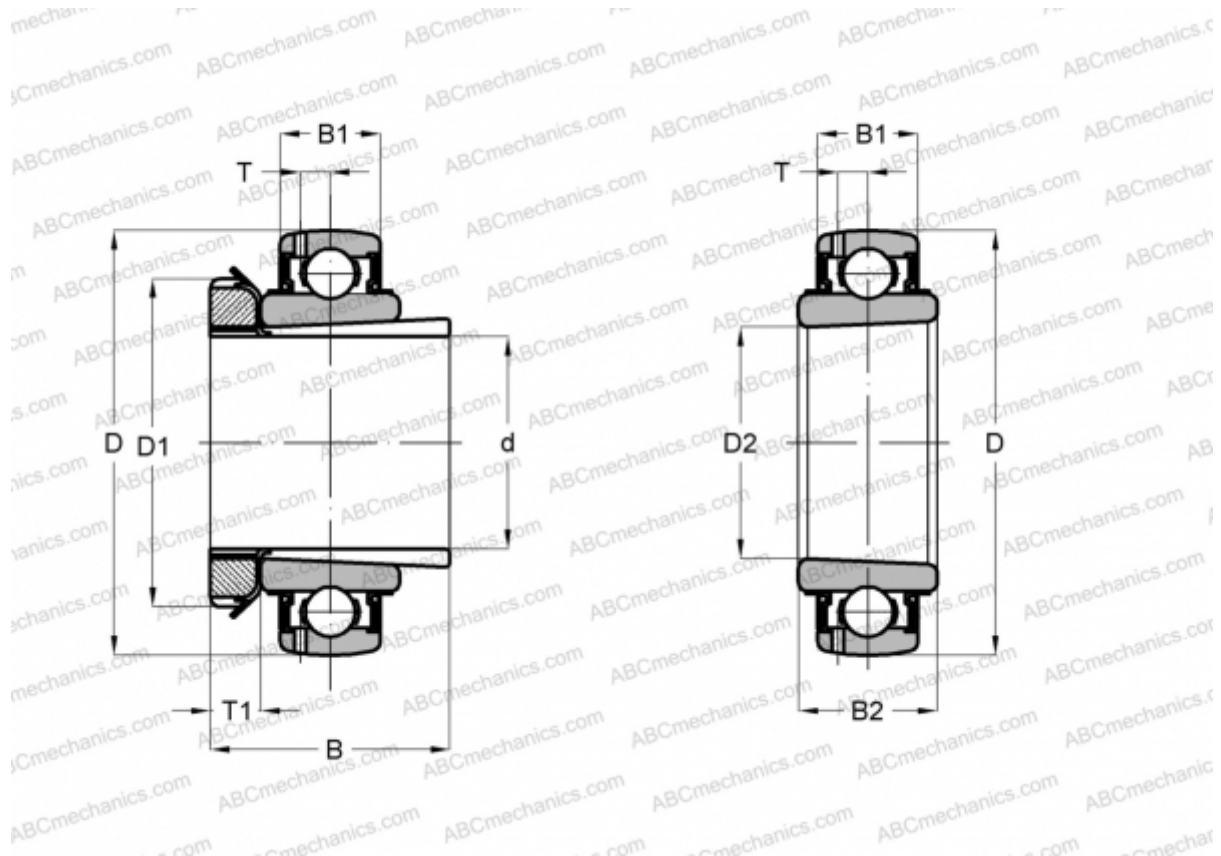

Technical specification

DIMENSIONS, MM

d	65,000
D	140,000
D1	98,000
D2	75,000
B	73,000
B1	32,000
B2	44,000
T	9,600
T1	15,000

WEIGHT, KG 3,250

MANUFACTURER [ASAHI](#)