

## UK X06 + HE2306 ASAHI

Insert bearings

TYPE: Ball bearings, Radial insert bearings, With adapter sleeve, Spherical outer ring, Series UK X, seals on both side, inch size

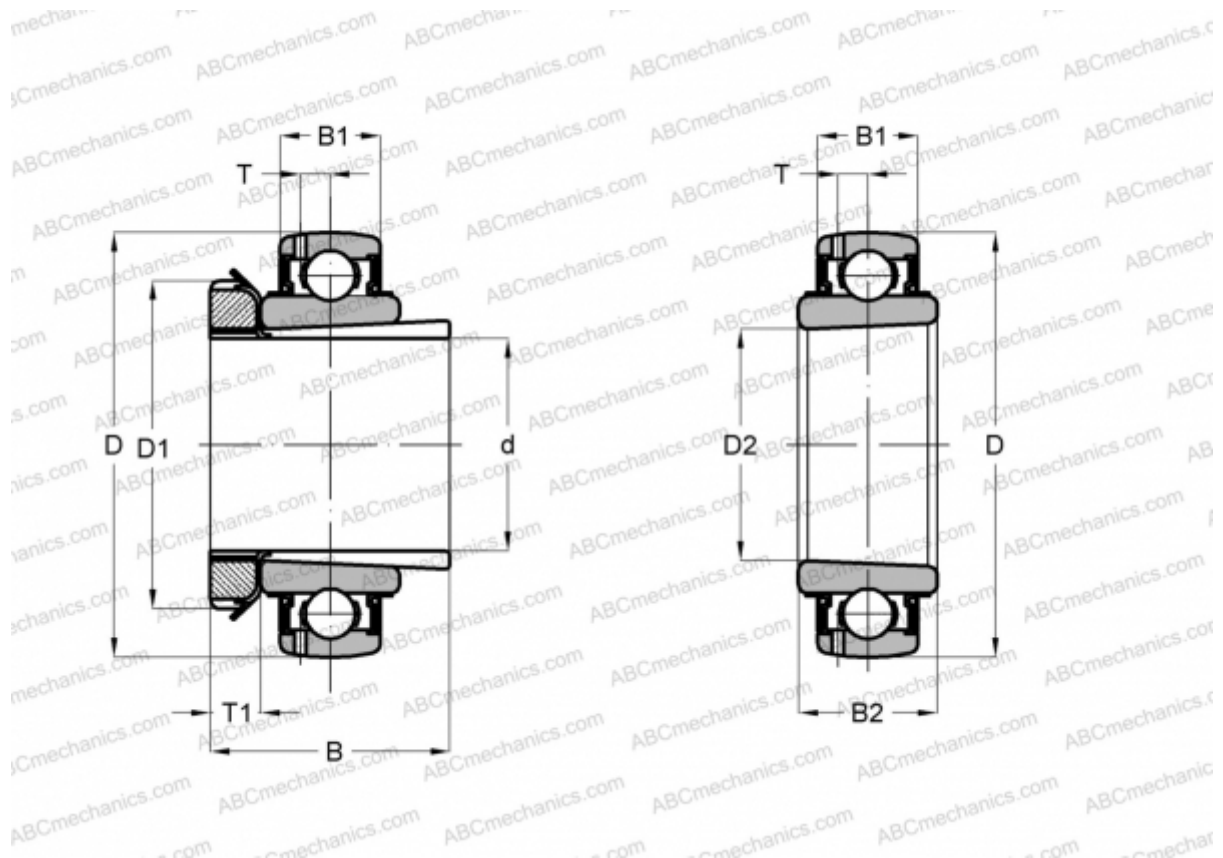

### Technical specification

#### DIMENSIONS, MM

d	25,400
D	71,999
D1	45,009
D2	30,000
B	37,998
B1	19,990
B2	27,000
T	5,791
T1	8,001

**WEIGHT, KG** 0,540

**MANUFACTURER** [ASAHI](#)