

UK X09 + HA2309 ASAHI

Insert bearings

TYPE: Ball bearings, Radial insert bearings, With adapter sleeve, Spherical outer ring, Series UK X, seals on both side, inch size

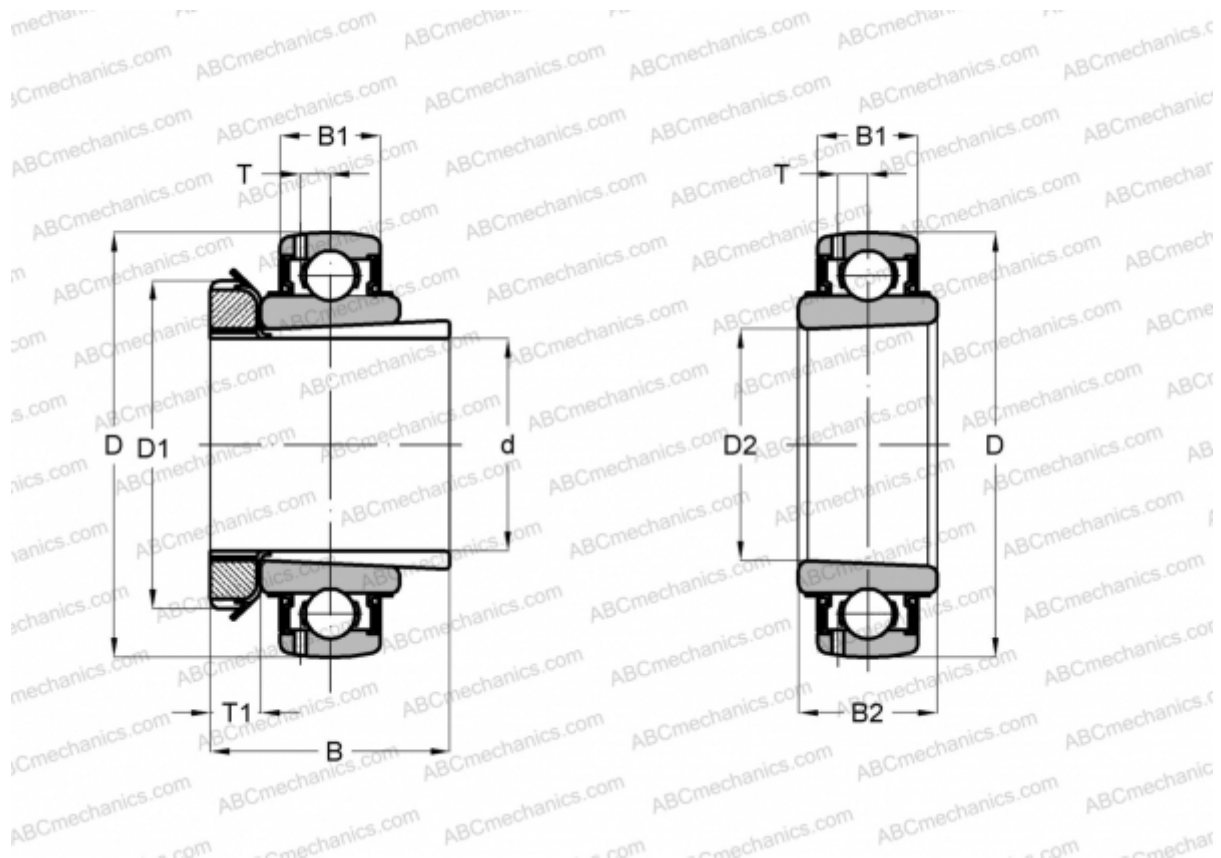

Technical specification

DIMENSIONS, MM

d	36,512
D	90,000
D1	64,999
D2	45,001
B	50,013
B1	23,012
B2	30,988
T	6,502
T1	10,998

WEIGHT, KG 0,939

MANUFACTURER [ASAHI](#)